



MAIGA & CO®

INTERNATIONAL



ALLAH KI YIRIWA



+90 535 941 47 28

+223 74 73 00 06

WWW.MAIGACO.COM

MAHAMADOUAIGA906@YAHOO.COM

● Retractable Bleachers Rear-facing Upholstered Seats

- ▶ Model:BL-STE-11-CG
- ▶ Metal Treatments:Powder Coating
- ▶ Pedal:18 mm melamine multilayer plywood
- ▶ Loading Capacity:≥5KN per square meters
- ▶ Guard Rail:3 Side safety Rail
- ▶ Aisles:1 meters width
- ▶ Applications:Multifunctional hall
- ▶ Structure Pillars: 50x100x3.5mm
- ▶ Beam:50x220x3mm
- ▶ Telescopic Mode: Electric
- ▶ Rows:11 (Customized size accepted)
- ▶ Row Depth:1000mm
- ▶ Row Rise:300mm
- ▶ Seating Capacity:290
- ▶ Seats C/C:500mm
- ▶ L/W/H:12000x11000x4400mm
- ▶ Seats Materail:Cast aluminum support, fire-resistant fabric, environmentally friendly sheet, high-density cold-foam olyurethane molding foam
- ▶ Design Standard:EN-13200

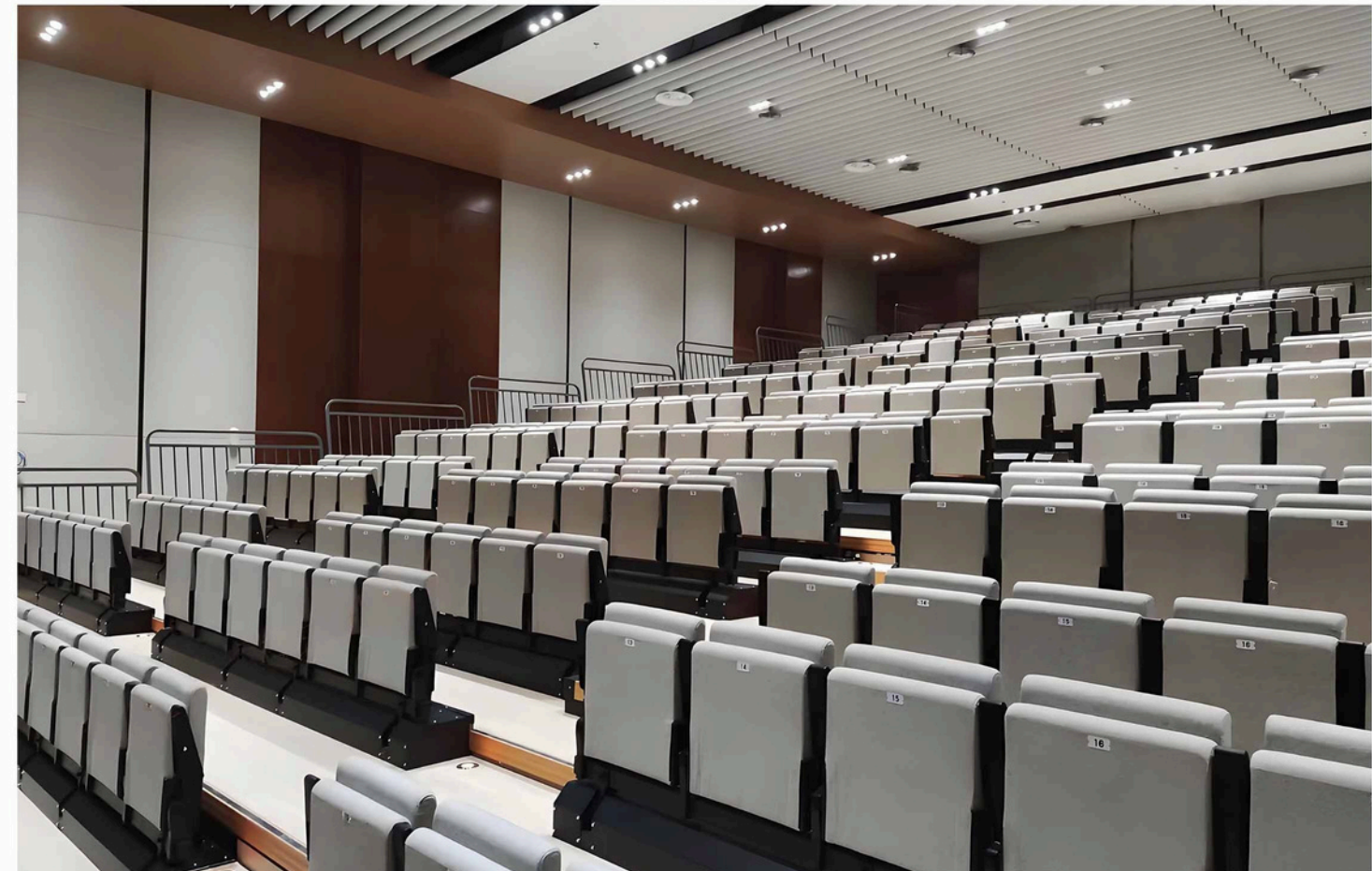

● Retractable Bleachers Rear-facing Upholstered Seats

- ▶ Model:BL-STE-06-CG
- ▶ Metal Treatments:Powder Coating
- ▶ Pedal: 18 mm melamine multilayer plywood
- ▶ Loading Capacity:≥5KN per square meters
- ▶ Guard Rail:3 Side safety Rail
- ▶ Aisles:1.3 meters width
- ▶ Applications:Multifunctional hall
- ▶ Structure Pillars: 50x100x3.5mm
- ▶ Beam:50x220x3mm
- ▶ Telescopic Mode: Electric
- ▶ Rows:6 (Customized size accepted)
- ▶ Row Depth:900mm
- ▶ Row Rise:300mm
- ▶ Seating Capacity:34
- ▶ Seats C/C:500mm
- ▶ L/W/H:5850x3919x2325mm
- ▶ Seats Materail:Cast aluminum support, fire-resistant fabric, environmentally friendly sheet, high-density cold-foam olyurethane molding foam
- ▶ Design Standard:EN-13200

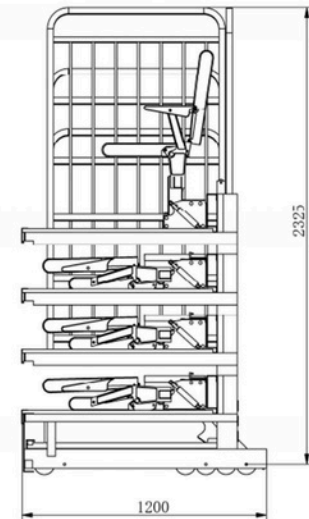
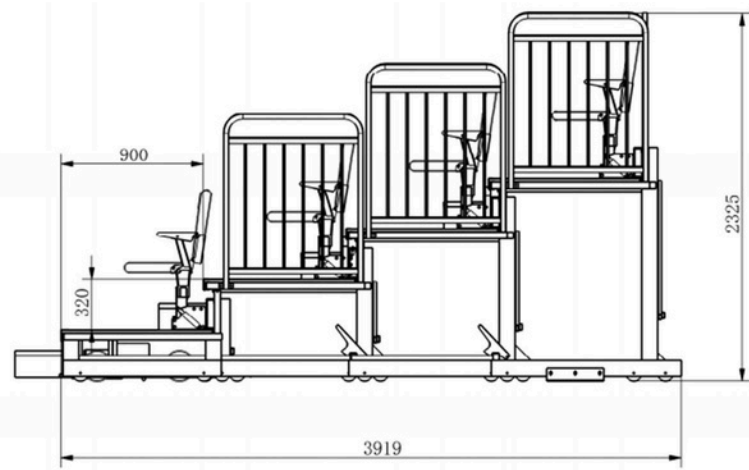
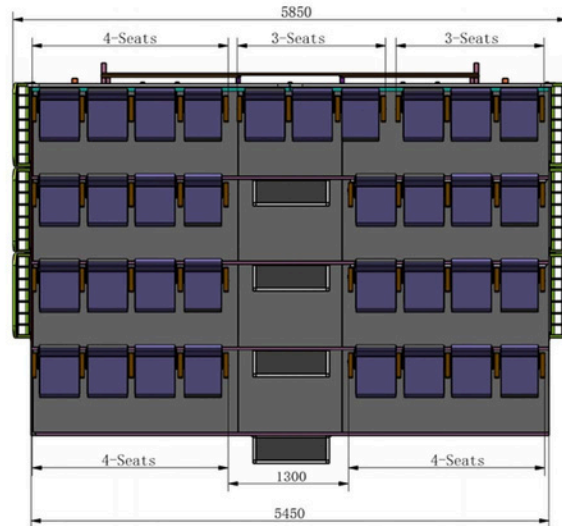
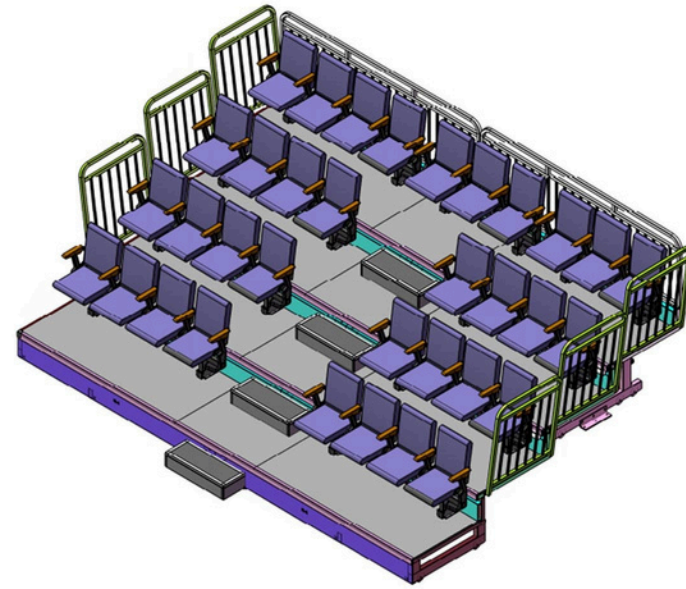
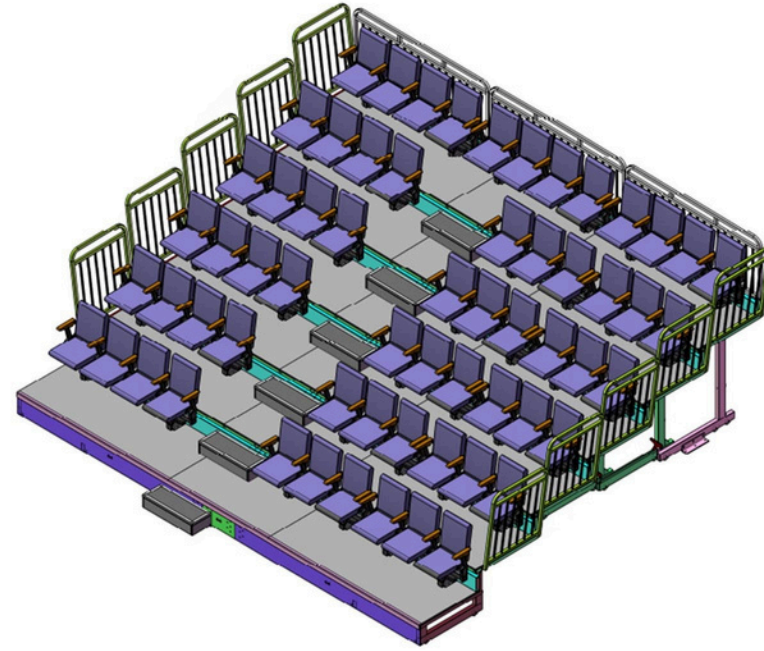

● Retractable Bleachers Folding Upholstered Seats

- ▶ Model:BL-STE-09-CB
- ▶ Metal Treatments:Powder Coating
- ▶ Pedal: 18 mm melamine multilayer plywood
- ▶ Loading Capacity:≥5KN per square meters
- ▶ Guard Rail:3 Side safety Rail
- ▶ Aisles:1 meters width
- ▶ Applications:Multifunctional hall
- ▶ Structure Pillars: 50x100x3.5mm
- ▶ Beam:50x220x3mm
- ▶ Telescopic Mode: Electric/Manual
- ▶ Rows:9 (Customized size accepted)
- ▶ Row Depth:900mm
- ▶ Row Rise:300mm
- ▶ Seating Capacity:276
- ▶ Seats C/C:500mm
- ▶ L/W/H:18000x7850x3464mm
- ▶ Seats Materail:Stamped steel bracket, environmentally friendly sheet, fireproof fabric, high-density cold foam polyurethane molding foam
- ▶ Design Standard:EN-13200

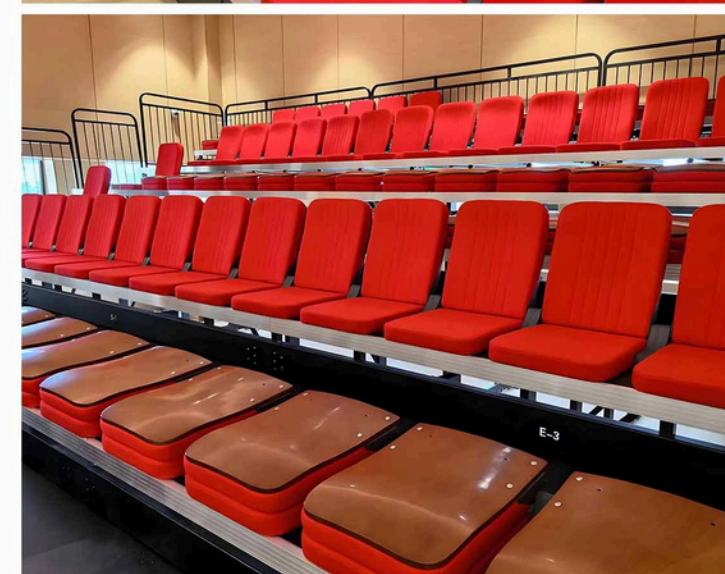
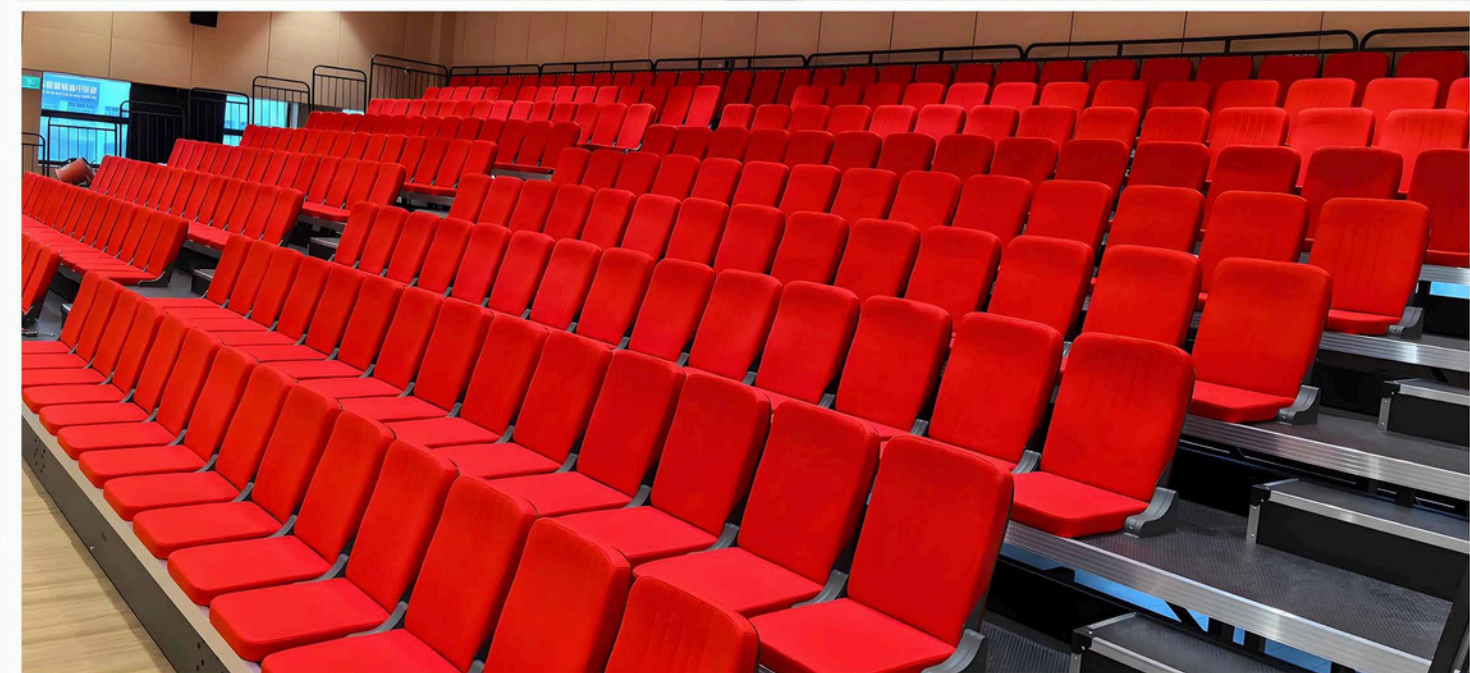
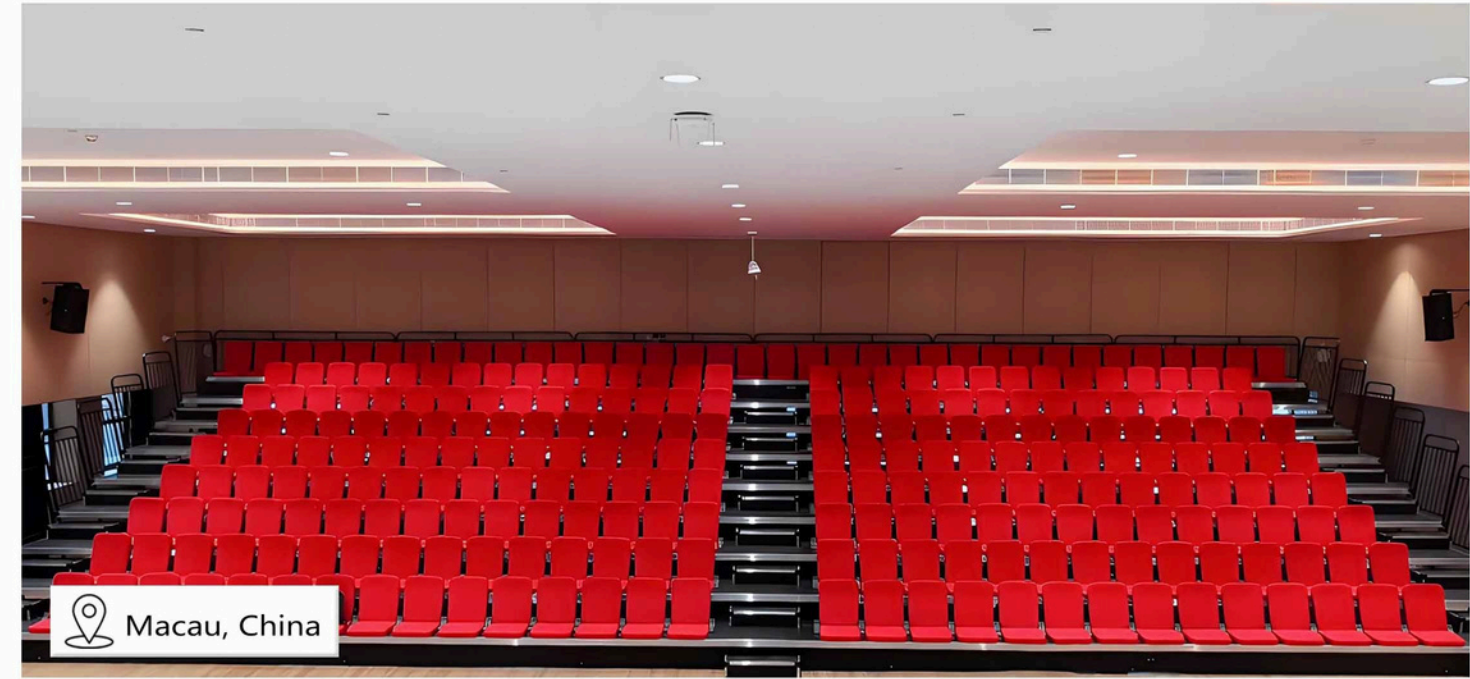
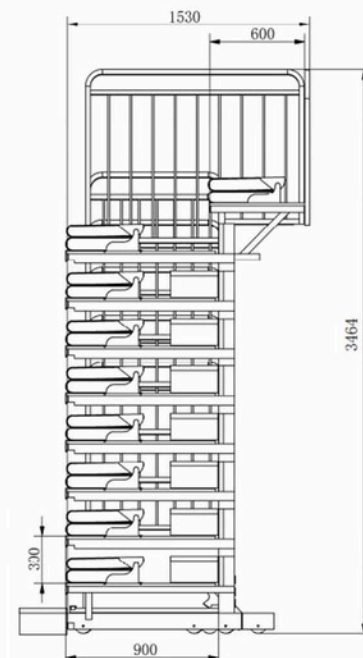
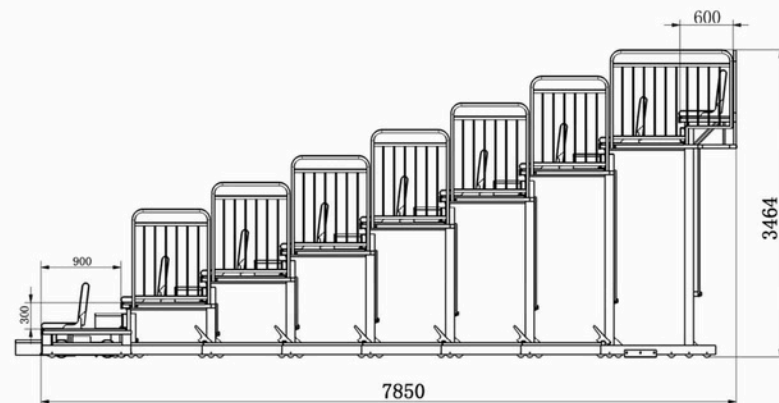
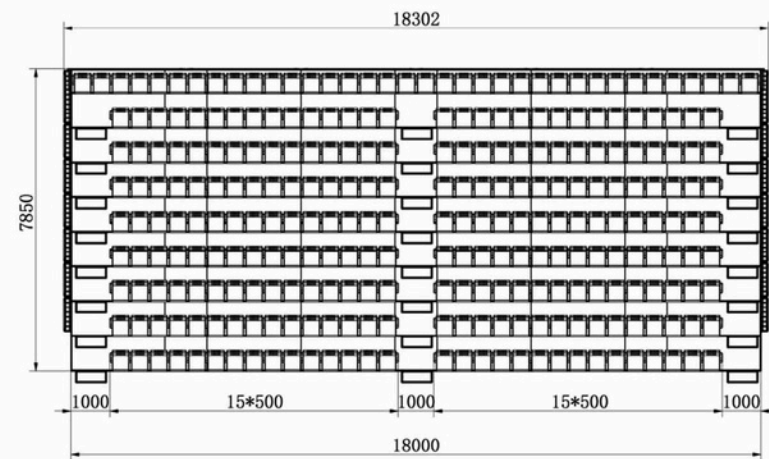
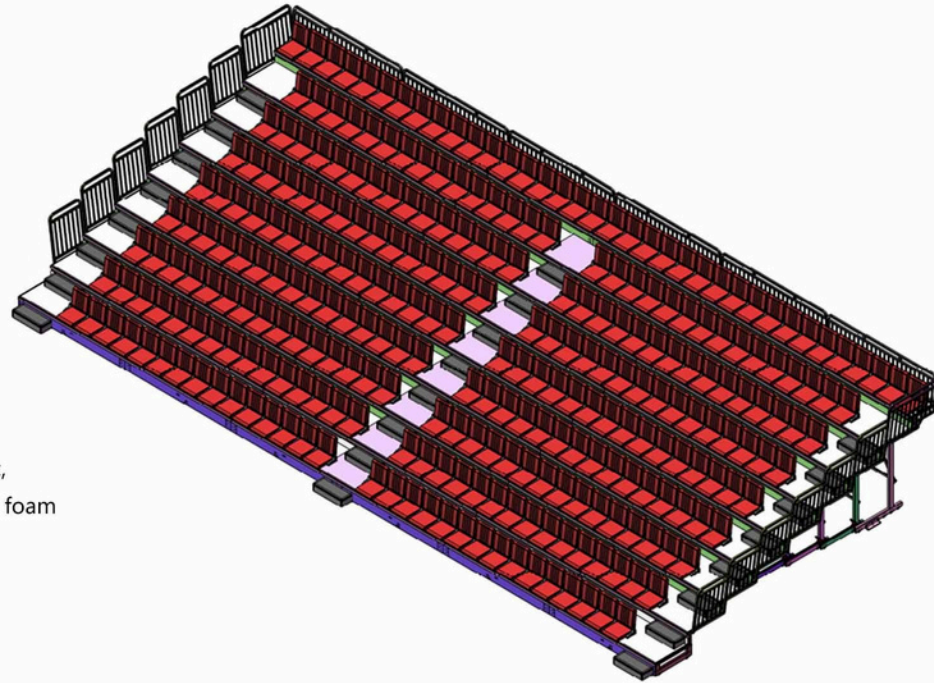

● Retractable Bleachers Folding Upholstered Seats

- ▶ Model:BL-STE-11-CB
- ▶ Metal Treatments:Powder Coating
- ▶ Pedal: 18 mm melamine multilayer plywood
- ▶ Loading Capacity:≥5KN per square meters
- ▶ Guard Rail:3 Side safety Rail
- ▶ Aisles:1 meters width
- ▶ Applications:Multifunctional hall
- ▶ Structure Pillars: 50x100x3.5mm
- ▶ Beam:50x220x3mm
- ▶ Telescopic Mode: Manual
- ▶ Rows:11 (Customized size accepted)
- ▶ Row Depth:900mm
- ▶ Row Rise:300mm
- ▶ Seating Capacity:202
- ▶ Seats C/C:500mm
- ▶ L/W/H:11000x9402x4260mm
- ▶ Seats Materail:Stamped steel bracket, environmentally friendly sheet, fireproof fabric, high-density cold foam polyurethane molding foam
- ▶ Design Standard:EN-13200

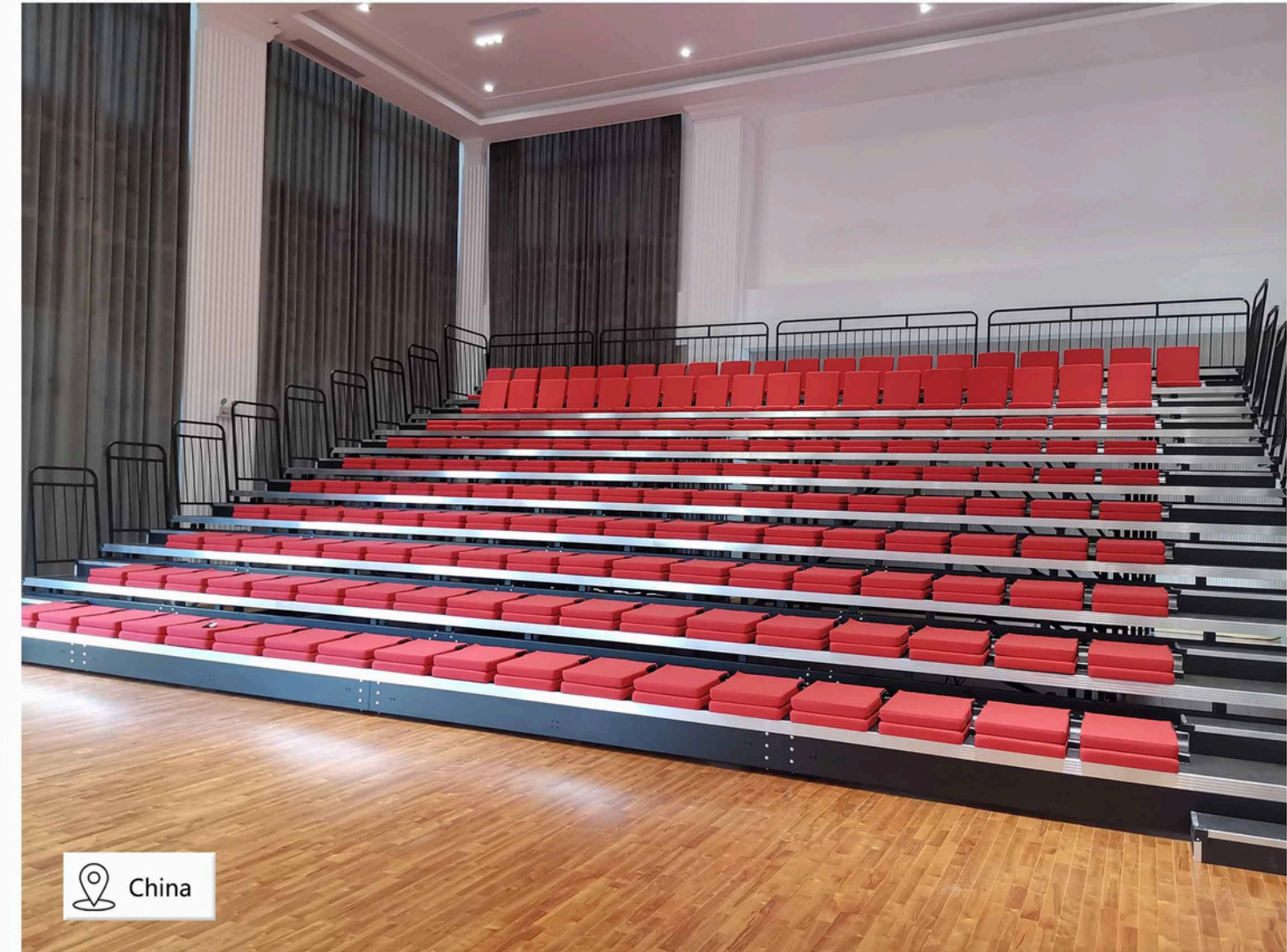
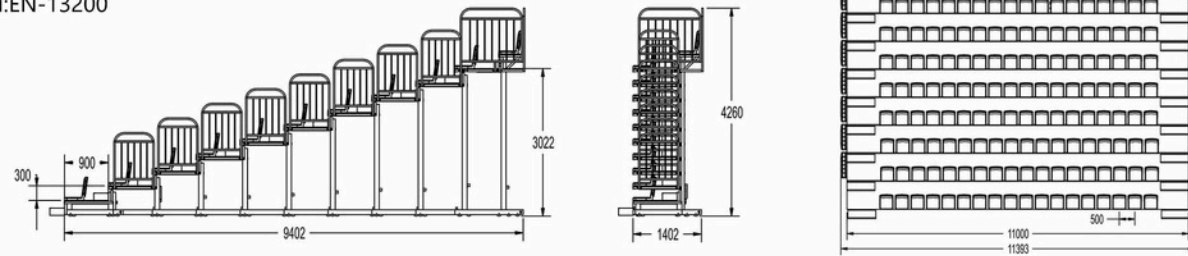
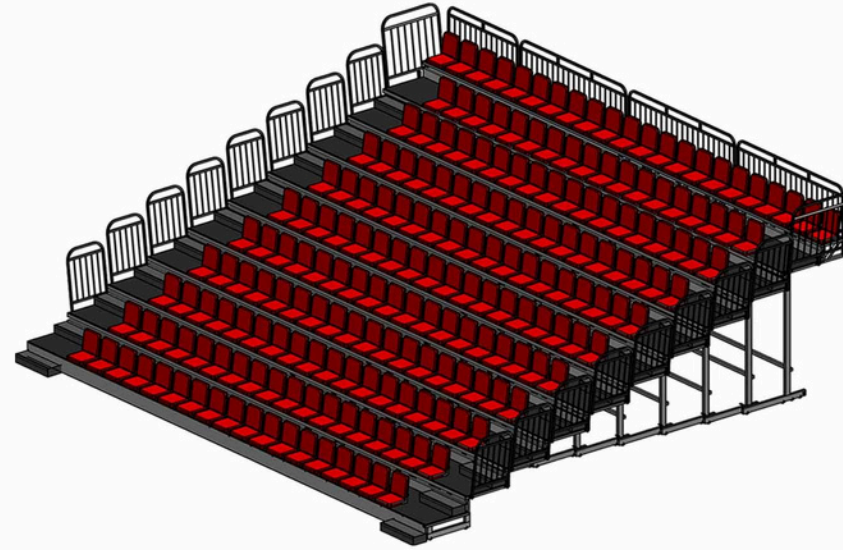

China

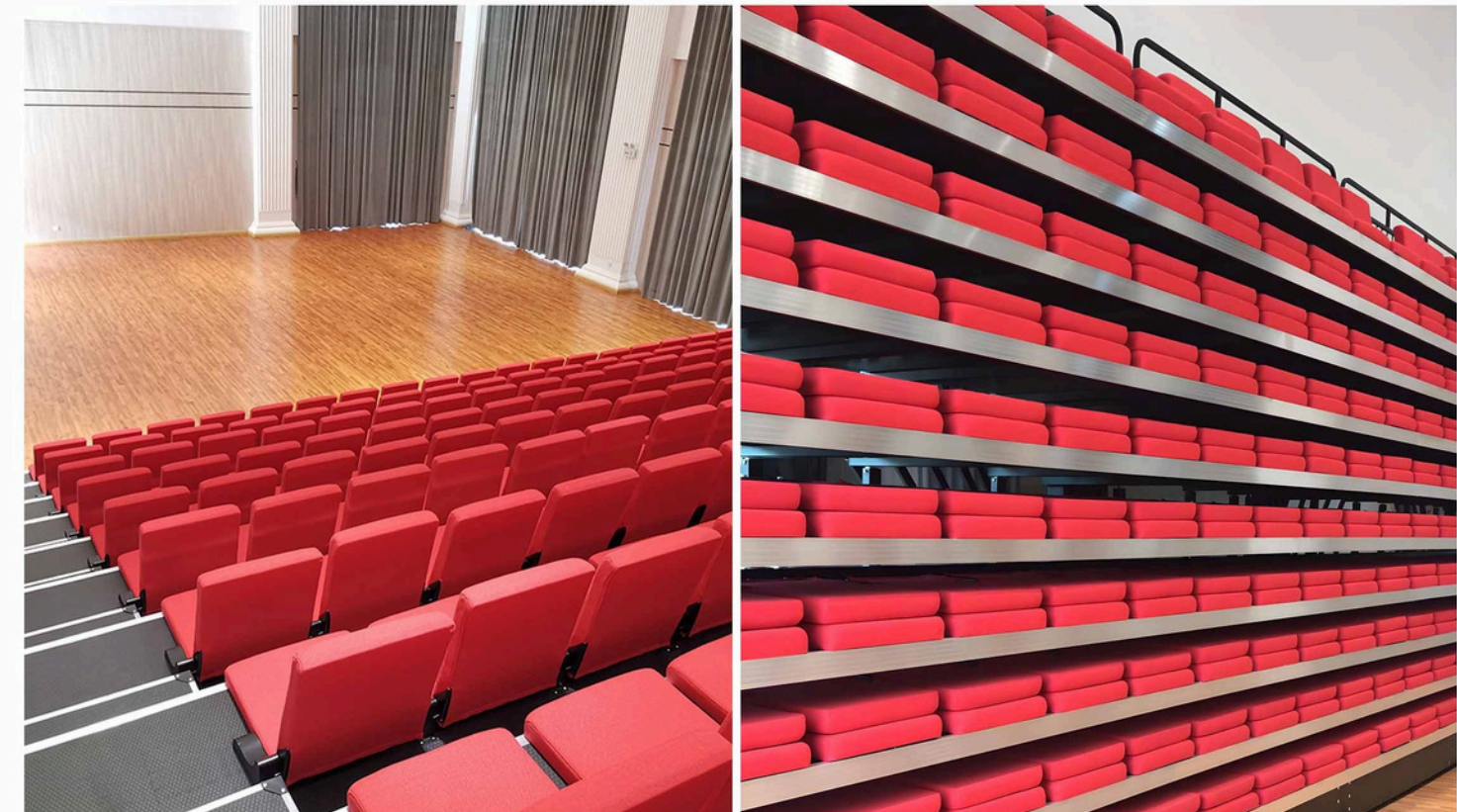

● Retractable Bleachers Folding Upholstered Seats

- ▶ Model:BL-STE-11-CB
- ▶ Metal Treatments:Powder Coating
- ▶ Pedal: 18 mm melamine multilayer plywood
- ▶ Loading Capacity:≥5KN per square meters
- ▶ Guard Rail:3 Side safety Rail
- ▶ Aisles:1 meters width
- ▶ Applications:Multifunctional hall
- ▶ Structure Pillars: 50x100x3.5mm
- ▶ Beam:50x220x3mm
- ▶ Telescopic Mode: Electric
- ▶ Rows:11 (Customized size accepted)
- ▶ Row Depth:900mm
- ▶ Row Rise:300mm
- ▶ Seating Capacity:290
- ▶ Seats C/C:500mm
- ▶ L/W/H:15000x9637x4320mm
- ▶ Seats Materail:Stamped steel bracket, environmentally friendly sheet, fireproof fabric, high-density cold foam polyurethane molding foam
- ▶ Design Standard:EN-13200

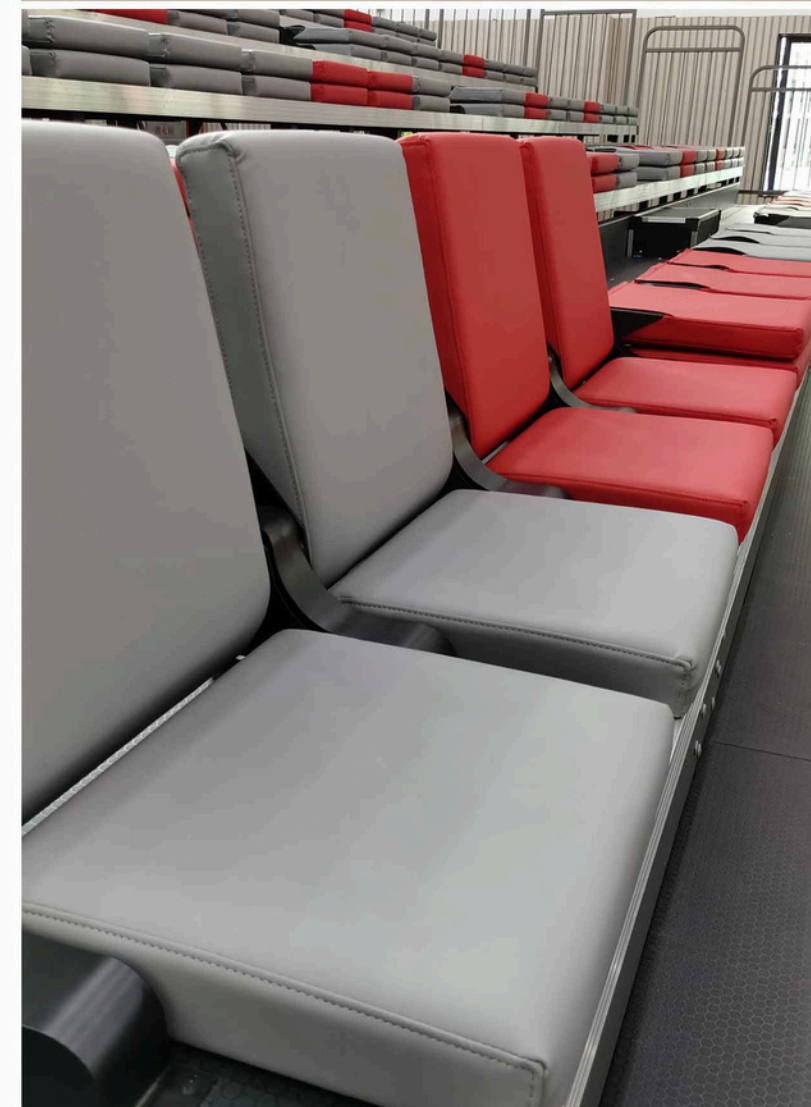
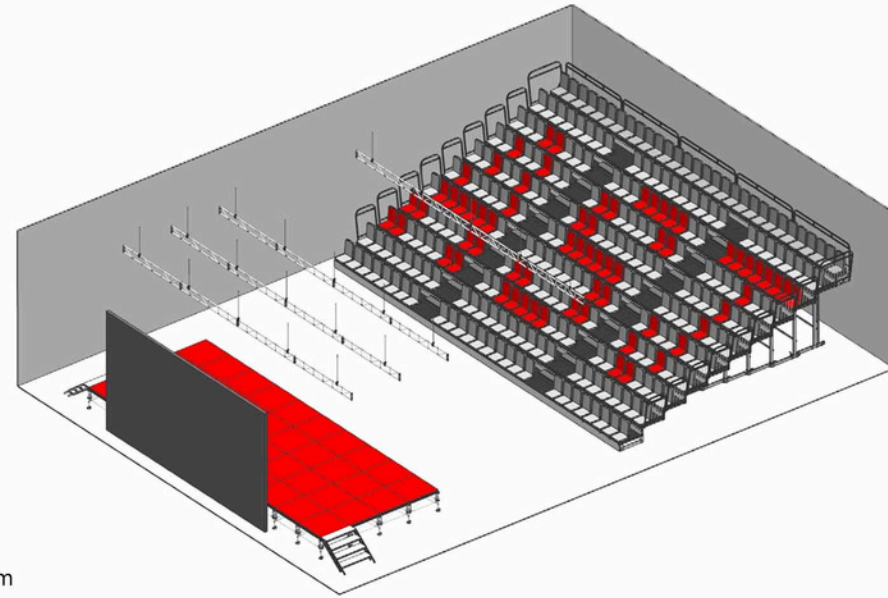

● Retractable Bleachers Folding Upholstered Seats

- ▶ Model:BL-STE-08-CB
 - ▶ Metal Treatments:Powder Coating
 - ▶ Pedal: 18 mm melamine multilayer plywood
 - ▶ Loading Capacity:≥5KN per square meters
 - ▶ Guard Rail:2 Side safety Rail
 - ▶ Aisles:1 meters width
 - ▶ Applications:Multifunctional hall
- ▶ Structure Pillars: 50x100x3.5mm
 - ▶ Beam:50x220x3mm
 - ▶ Telescopic Mode: Manual
 - ▶ Rows:8 (Customized size accepted)
 - ▶ Row Depth:750mm
 - ▶ Row Rise:300mm
 - ▶ Seating Capacity:202
- ▶ Seats C/C:500mm
 - ▶ L/W/H:10000x6000x3500mm
 - ▶ Seats Material:Stamped steel bracket, environmentally friendly sheet, fireproof fabric, high-density cold foam polyurethane molding foam
 - ▶ Design Standard:EN-13200

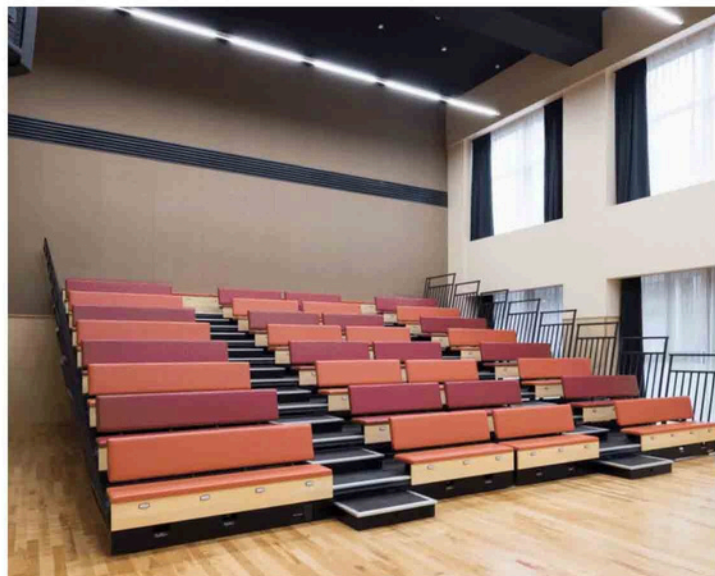
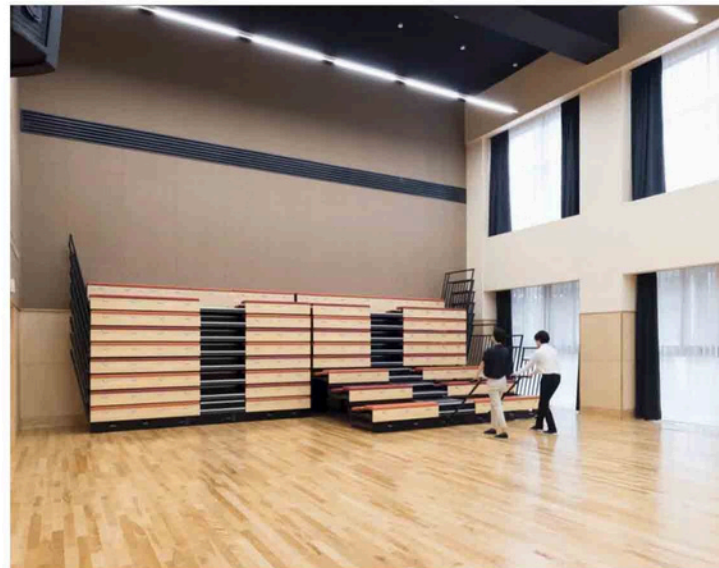
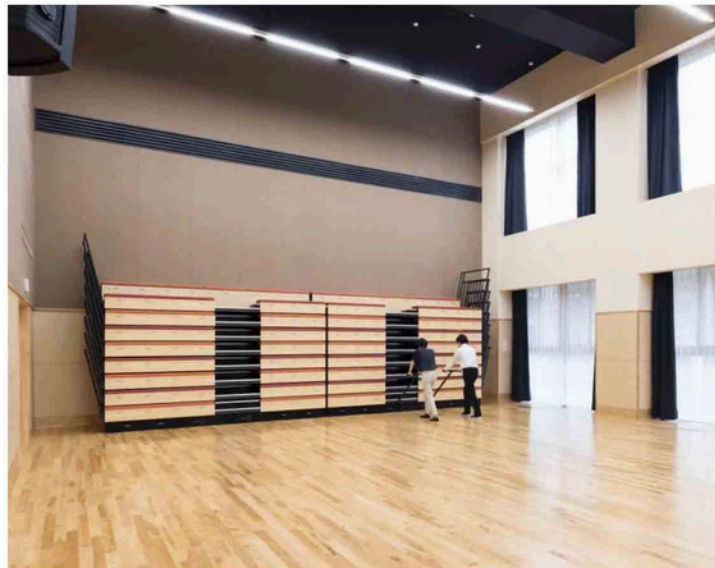
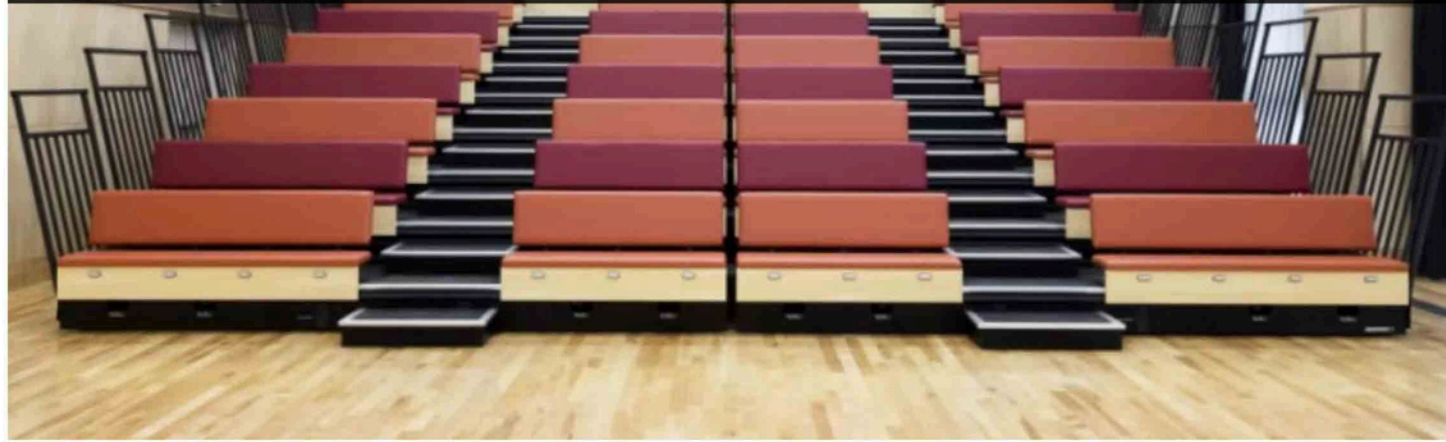

● Retractable Bleachers Folding Upholstered Seats

- ▶ Model:BL-STE-03-CB
- ▶ Metal Treatments:Powder Coating
- ▶ Pedal: 18 mm melamine multilayer plywood
- ▶ Loading Capacity:≥5KN per square meters
- ▶ Guard Rail:2 Side safety Rail
- ▶ Aisles:1 meters width
- ▶ Applications:Multifunctional hall
- ▶ Structure Pillars: 50x100x3.5mm
- ▶ Beam:50x220x3mm
- ▶ Telescopic Mode: Manual
- ▶ Rows:3 (Customized size accepted)
- ▶ Row Depth:750mm
- ▶ Row Rise:300mm
- ▶ Seating Capacity:26
- ▶ Seats C/C:500mm
- ▶ L/W/H:5000x2250x2000mm
- ▶ Seats Material:Stamped steel bracket, environmentally friendly sheet, fireproof fabric, high-density cold foam polyurethane molding foam
- ▶ Design Standard:EN-13200

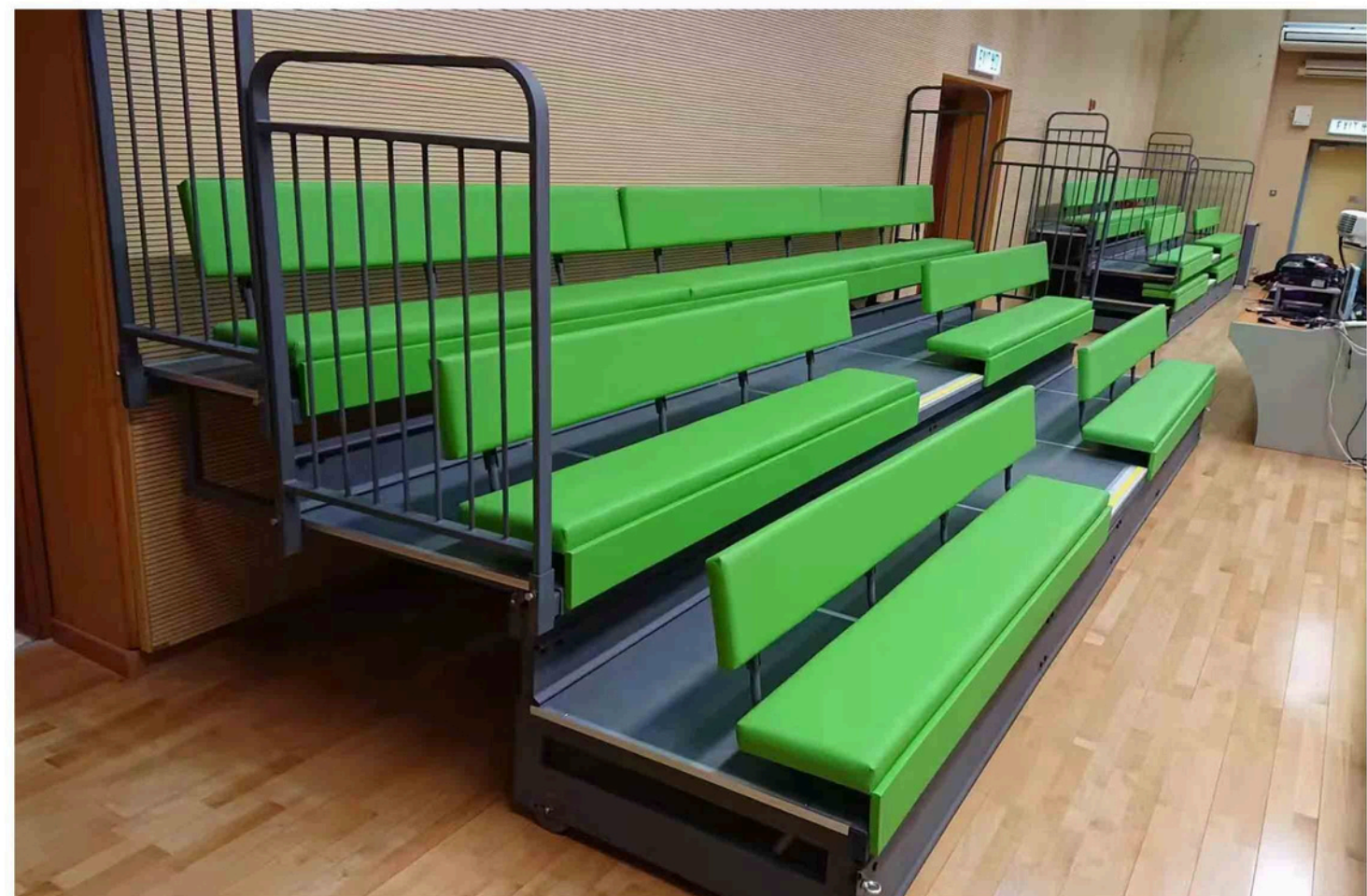
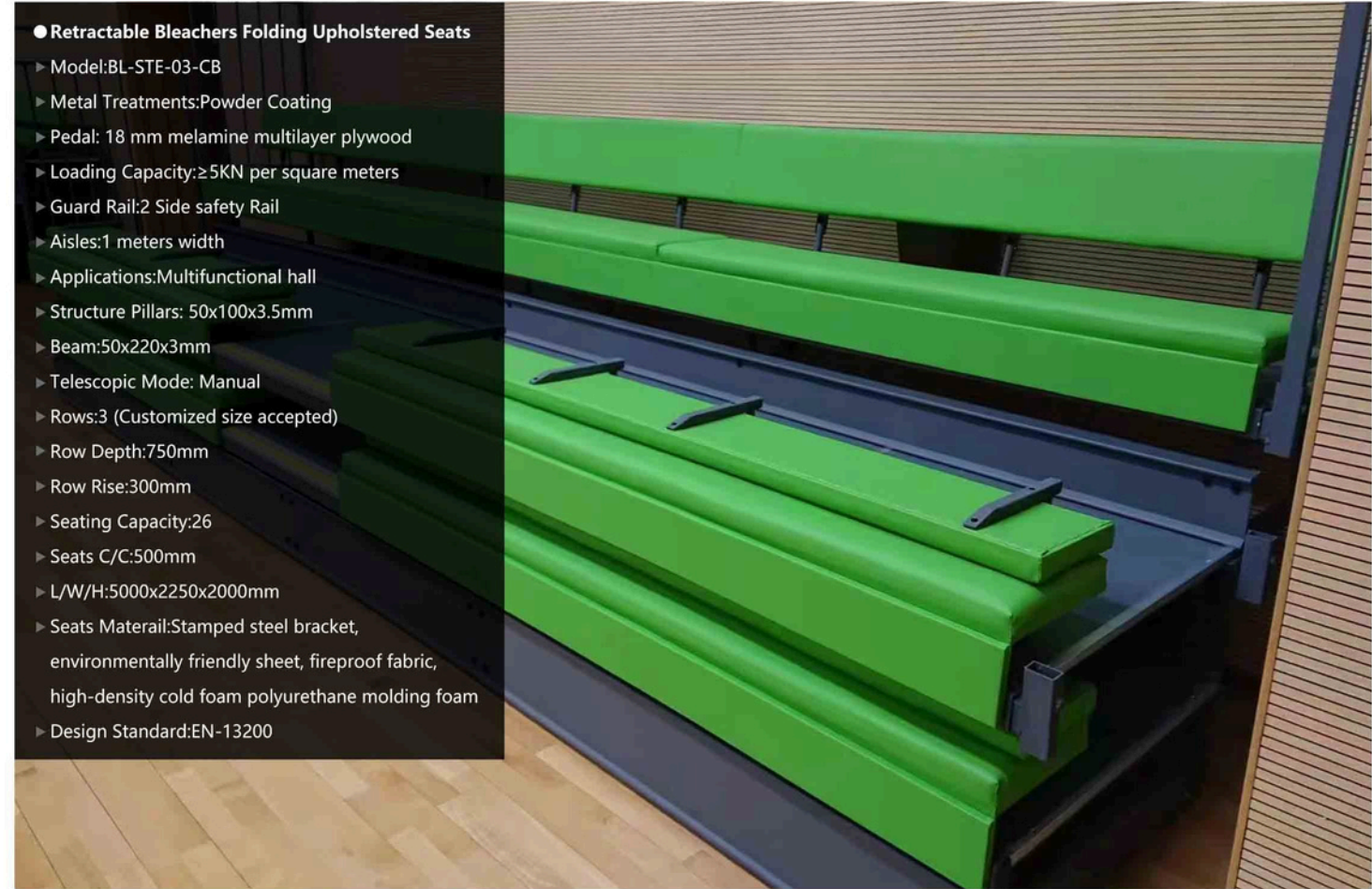

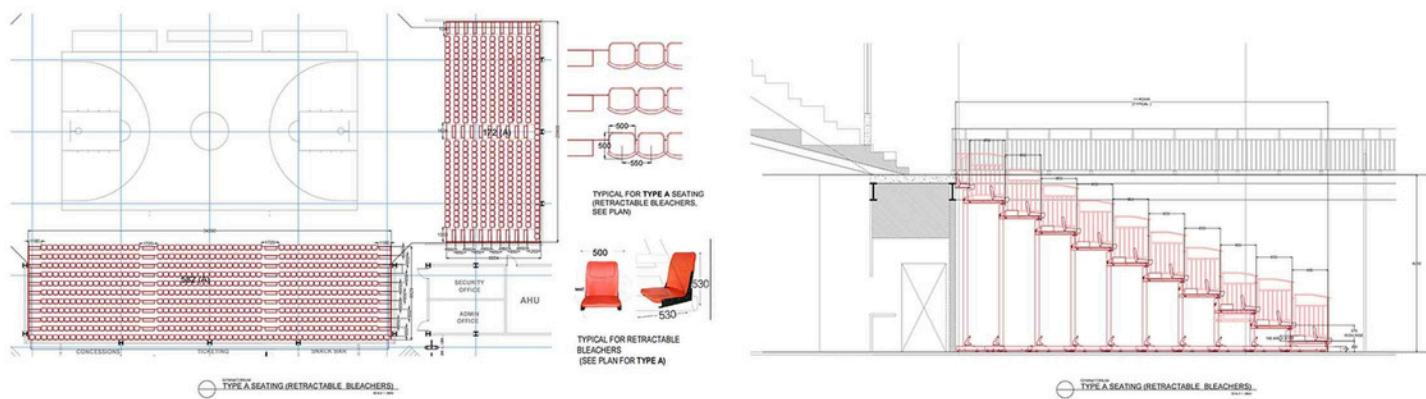
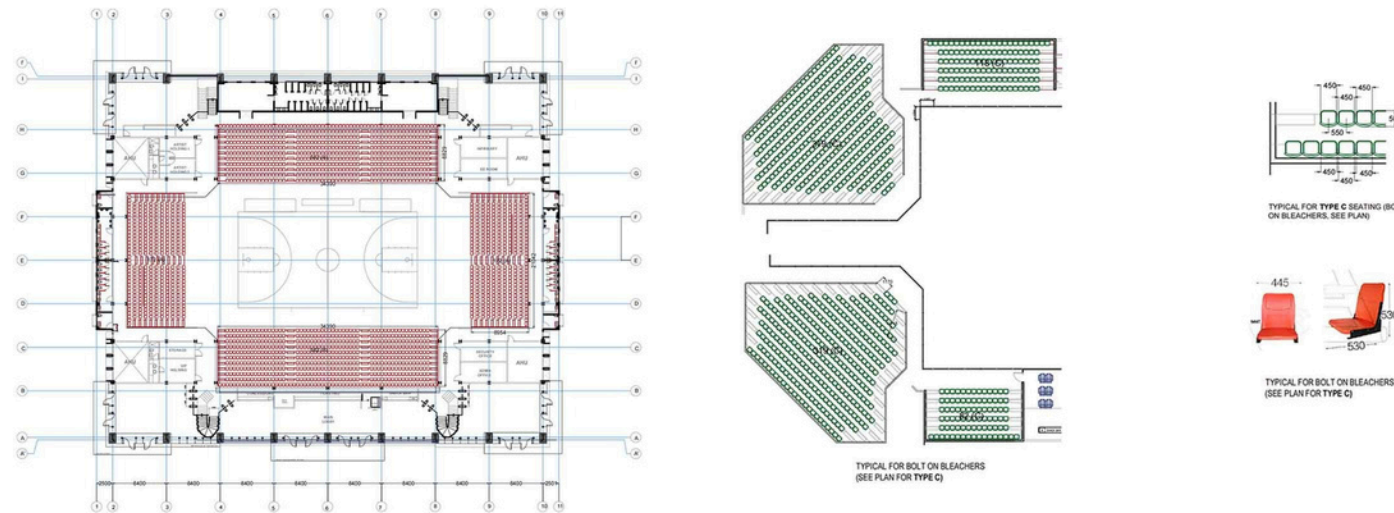
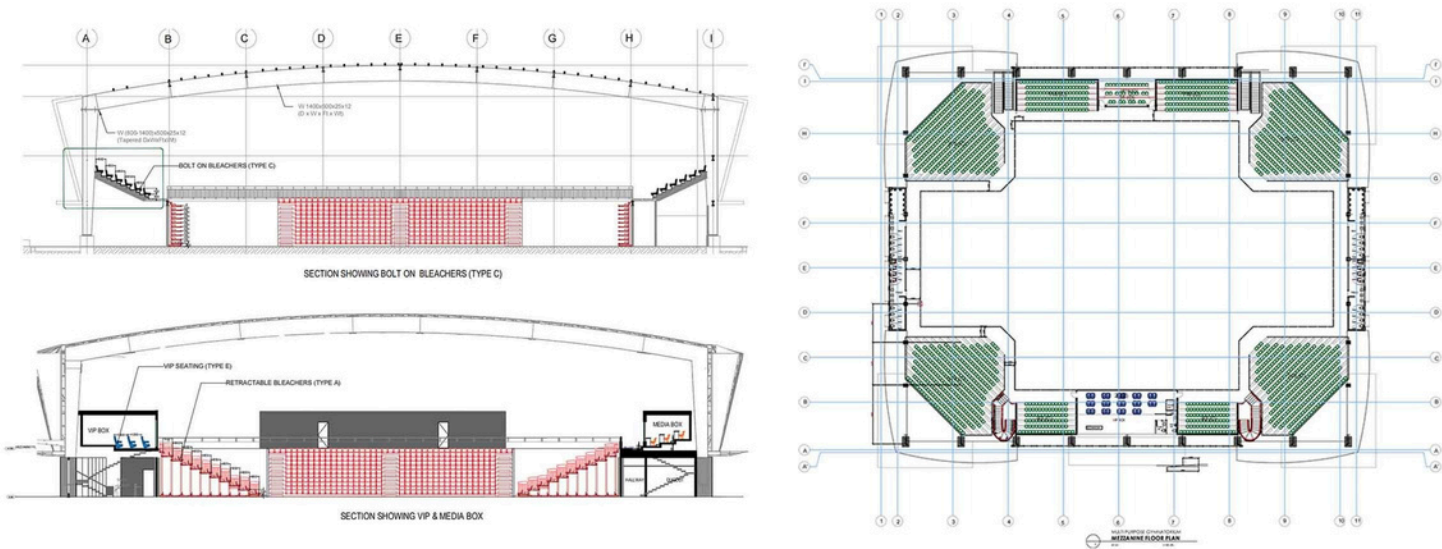

- Retractable Bleachers Folding Plastic Seats
- ▶ Model:BL-STE-11-CF
- ▶ Metal Treatments:Powder Coating
- ▶ Pedal: 18 mm melamine multilayer plywood
- ▶ Loading Capacity:≥25KN per square meters
- ▶ Guard Rail:2 Side safety Rail
- ▶ Aisles:1 meters width
- ▶ Applications:Indoor basketball court
- ▶ Structure Pillars: 50x100x3.5mm
- ▶ Beam:50x220x3mm
- ▶ Rows:11 (Customized size accepted)
- ▶ Row Depth:850mm
- ▶ Row Rise:375mm
- ▶ Seating Capacity:1860
- ▶ Seats C/C:500mm
- ▶ L/W/H:34390x9350x5225mm
- ▶ Telescopic Mode: Electric
- ▶ Seats Materail:HDPE
- ▶ Design Standard:EN-13200



● Retractable Bleachers Folding Plastic Seats

- ▶ Model: BL-STE-10-CF
- ▶ Metal Treatments: Powder Coating
- ▶ Pedal: 18 mm melamine multilayer plywood
- ▶ Loading Capacity: $\geq 5\text{KN}$ per square meters
- ▶ Guard Rail: 3 Side safety Rail
- ▶ Aisles: 1.25 meters width
- ▶ Applications: Outdoor performance
- ▶ Structure Pillars: 50x100x3.5mm
- ▶ Beam: 50x220x3mm
- ▶ Telescopic Mode: Electric
- ▶ Rows: 10 (Customized size accepted)
- ▶ Row Depth: 800mm
- ▶ Row Rise: 300mm
- ▶ Seating Capacity: 255
- ▶ Seats C/C: 500mm
- ▶ L/W/H: 15000x8025x3900mm
- ▶ Seats Material: HDPE
- ▶ Design Standard: EN-13200

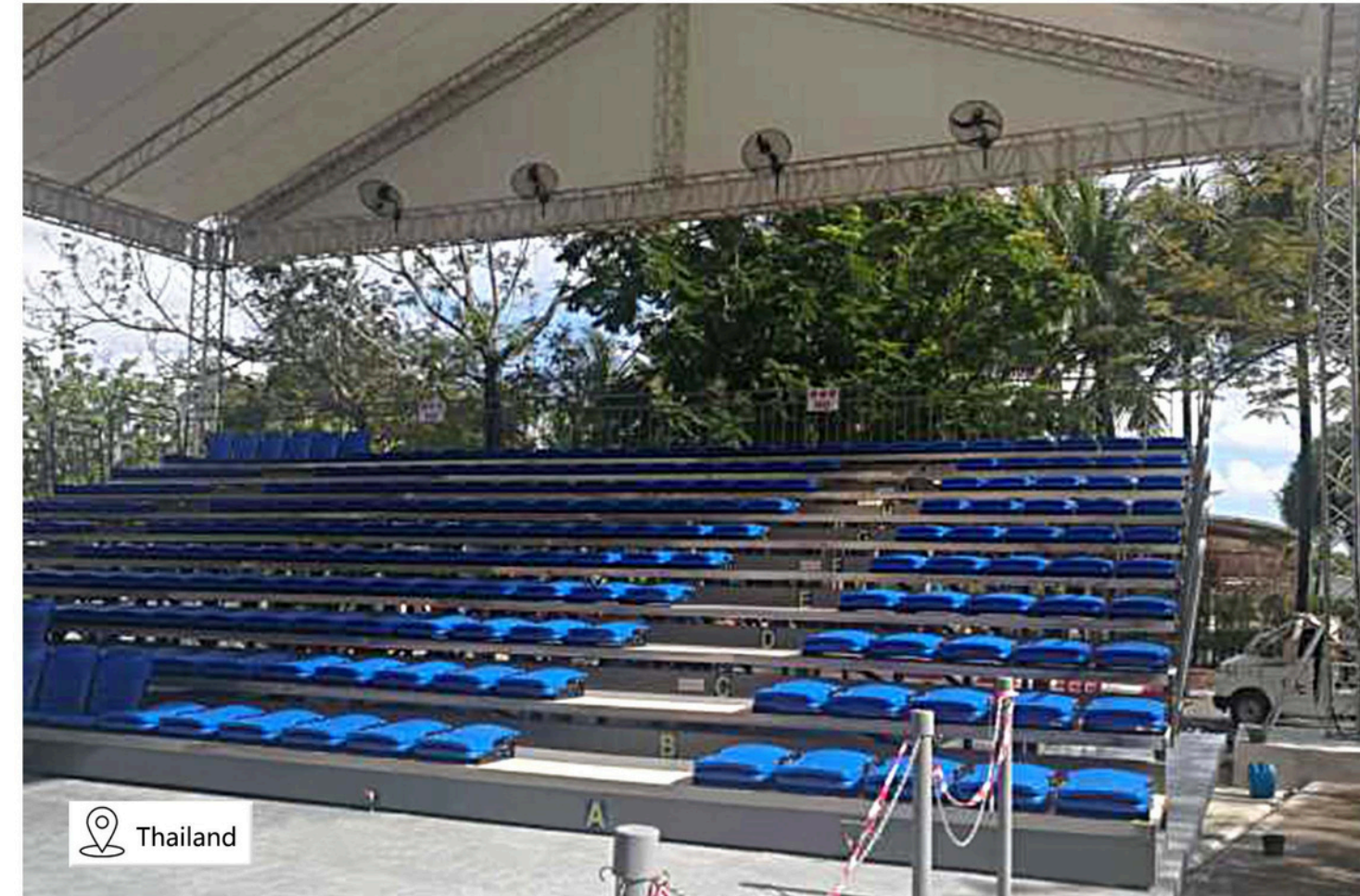
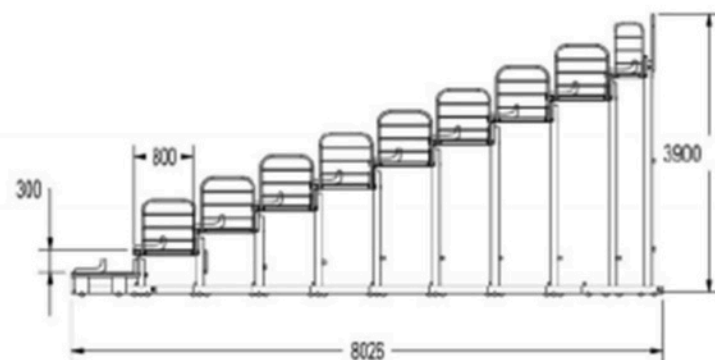
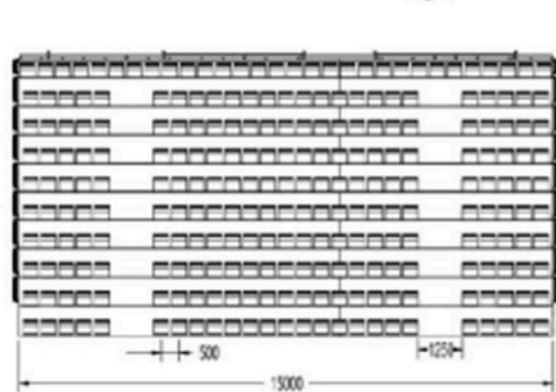
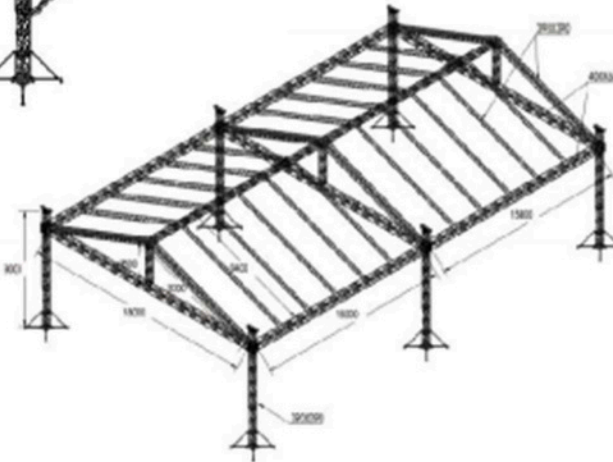
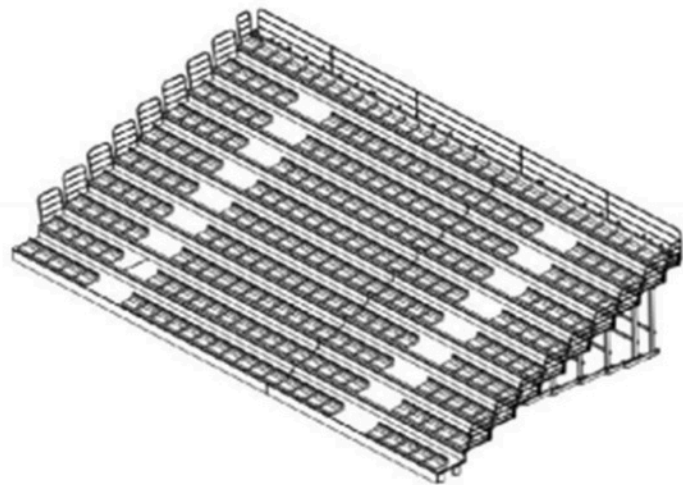
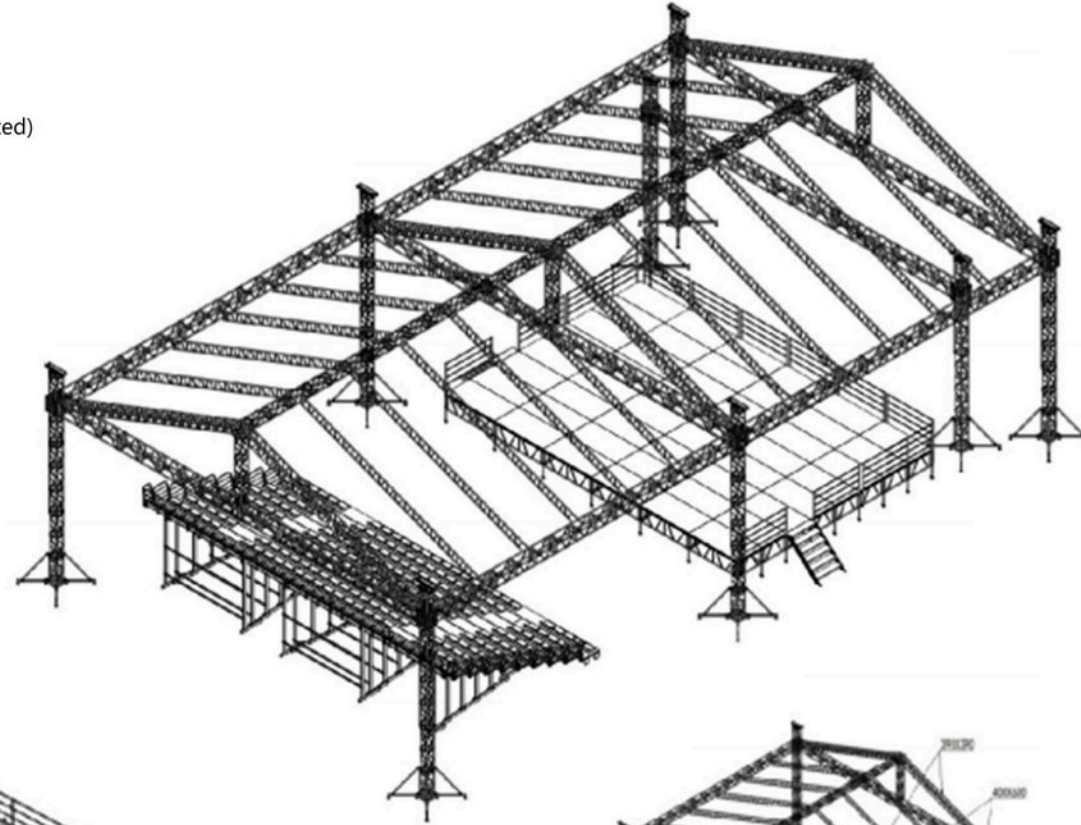

Thailand



● 360° movable retractble bleachers

- ▶ Model:BL-STE-04-CE
- ▶ Metal Treatments:Powder Coating
- ▶ Pedal: 18 mm melamine multilayer plywood
- ▶ Loading Capacity:≥5KN per square meters
- ▶ Guard Rail:3 Side safety Rail
- ▶ Aisles:1 meters width
- ▶ Applications:Indoor basketball court
- ▶ Structure Pillars: 50x100x3.5mm
- ▶ Beam:50x220x3mm
- ▶ Telescopic Mode: Manual
- ▶ Rows:4 (Customized size accepted)
- ▶ Row Depth:900mm
- ▶ Row Rise:300mm
- ▶ Seating Capacity:50
- ▶ Seats C/C:430mm
- ▶ L/W/H:6393x3202x2166mm
- ▶ Seats Materail:HDPE
- ▶ Design Standard:EN-13200

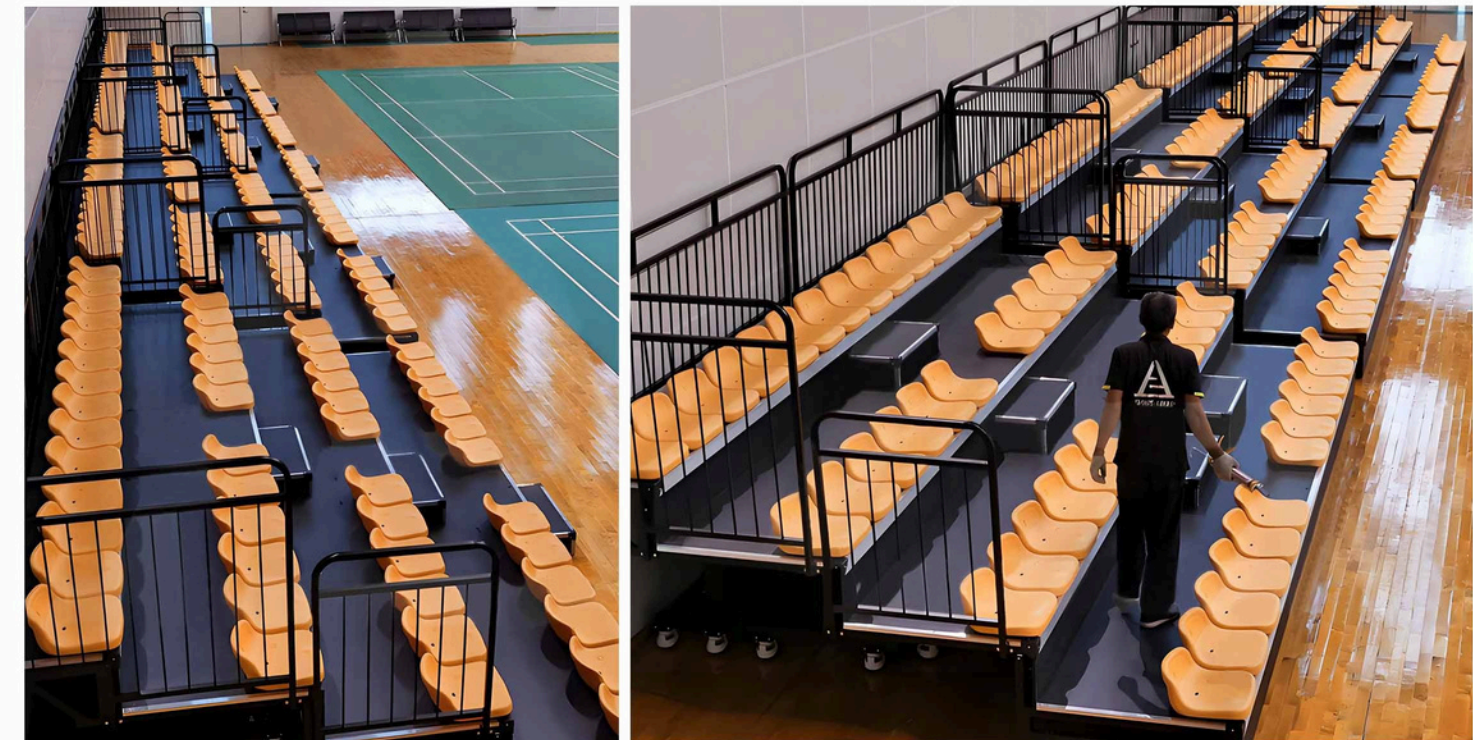
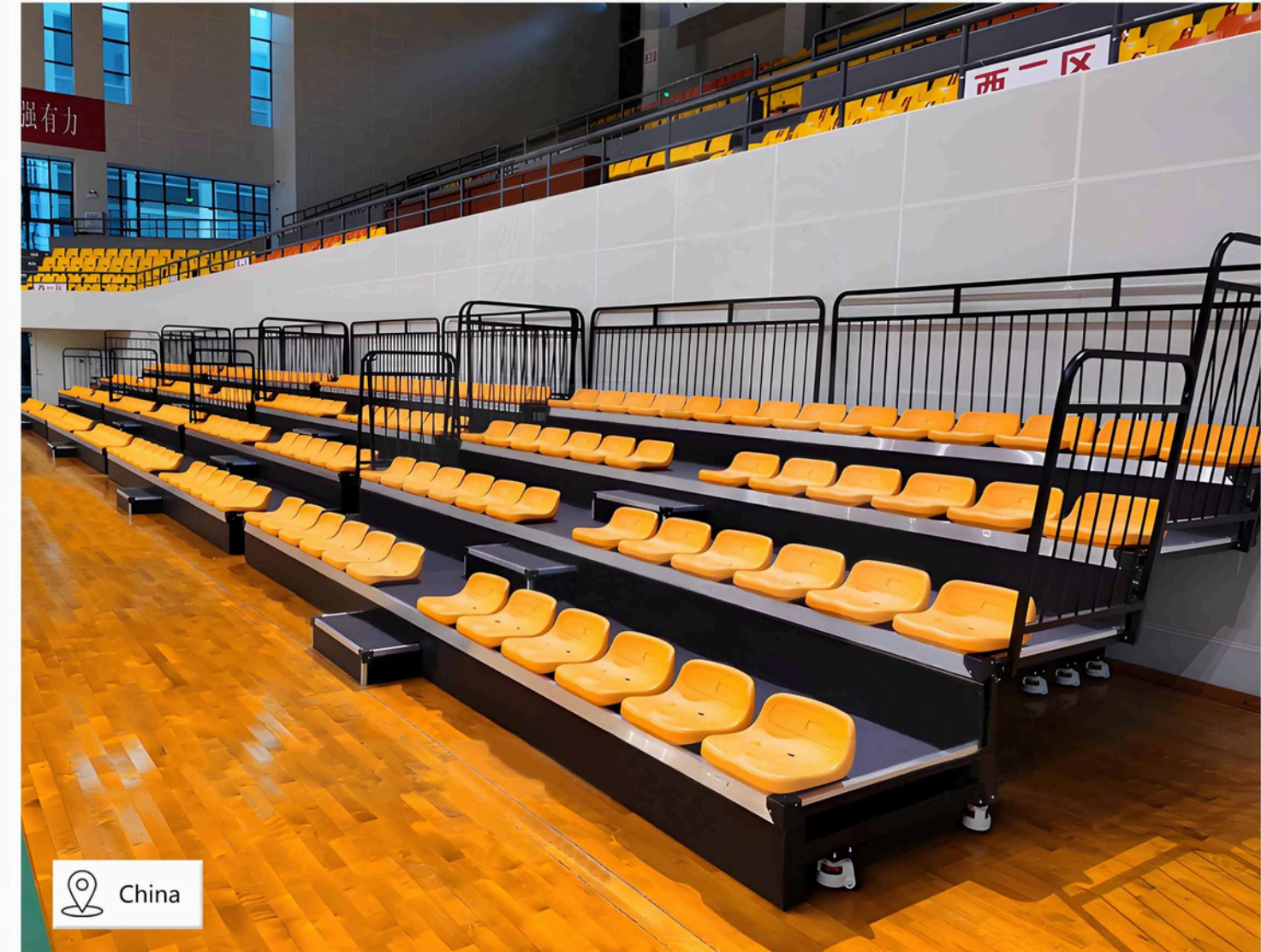
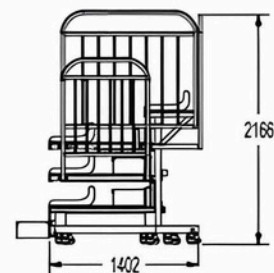
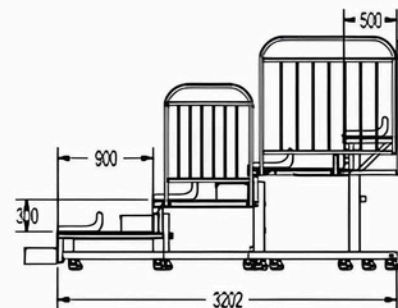
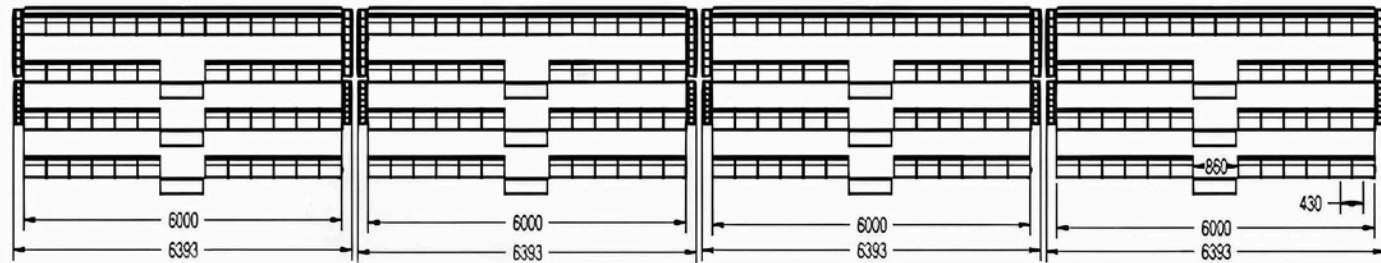
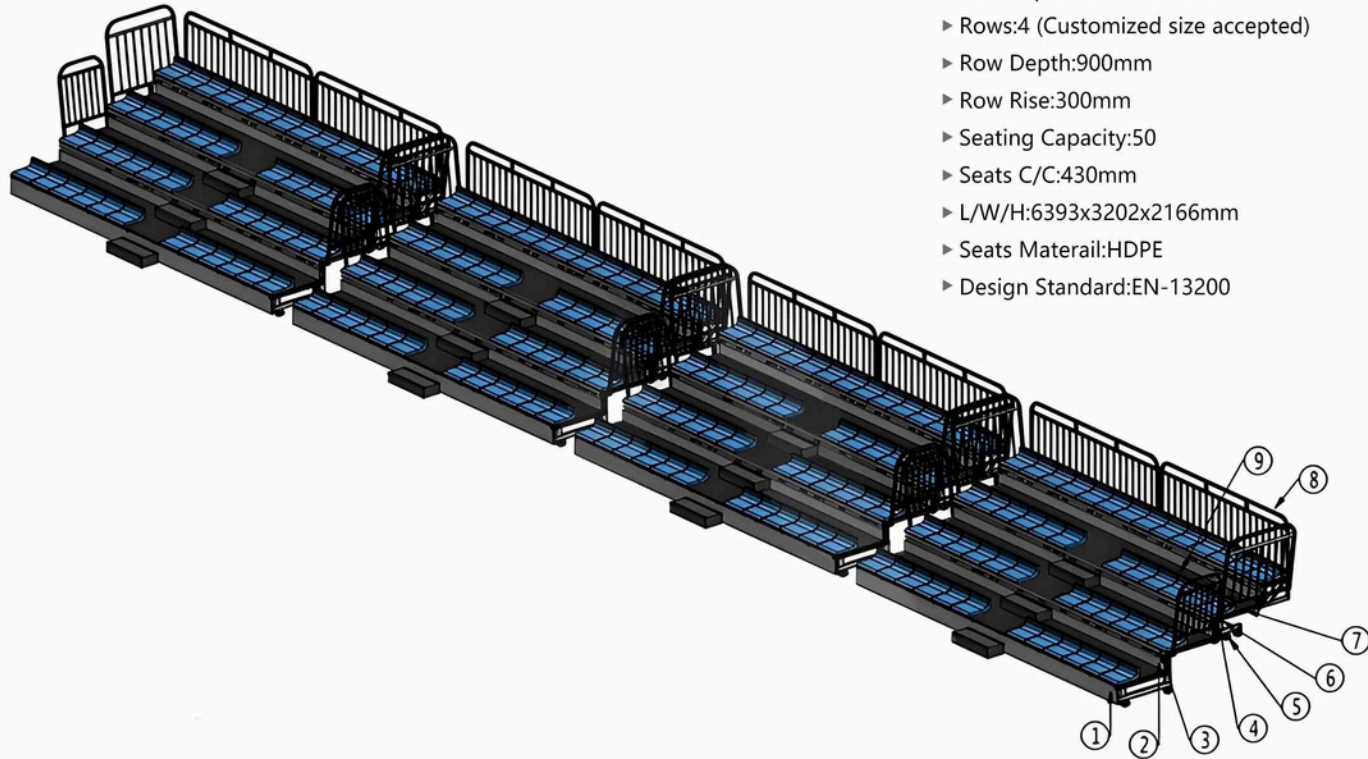



- This bleachers for my company's research and development of patented products for all types of sports venues, cultural performances, rapid deployment of audience bleacher seating system, fast and flexible, space-saving, save installation time.

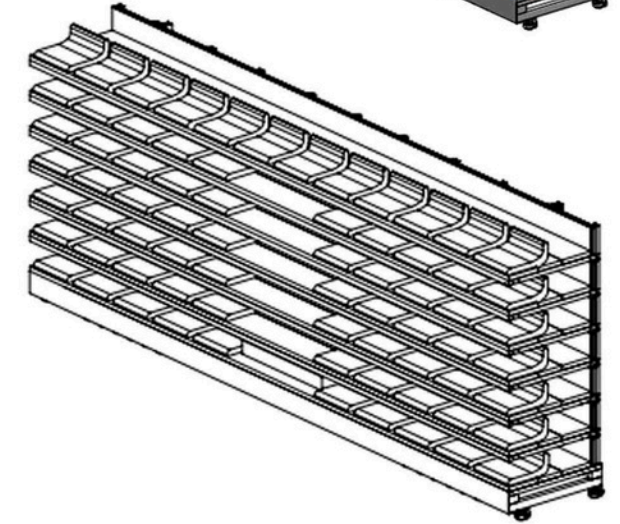
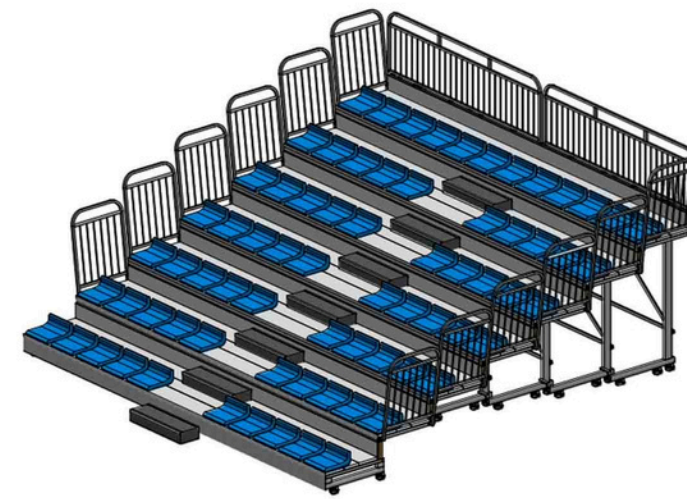
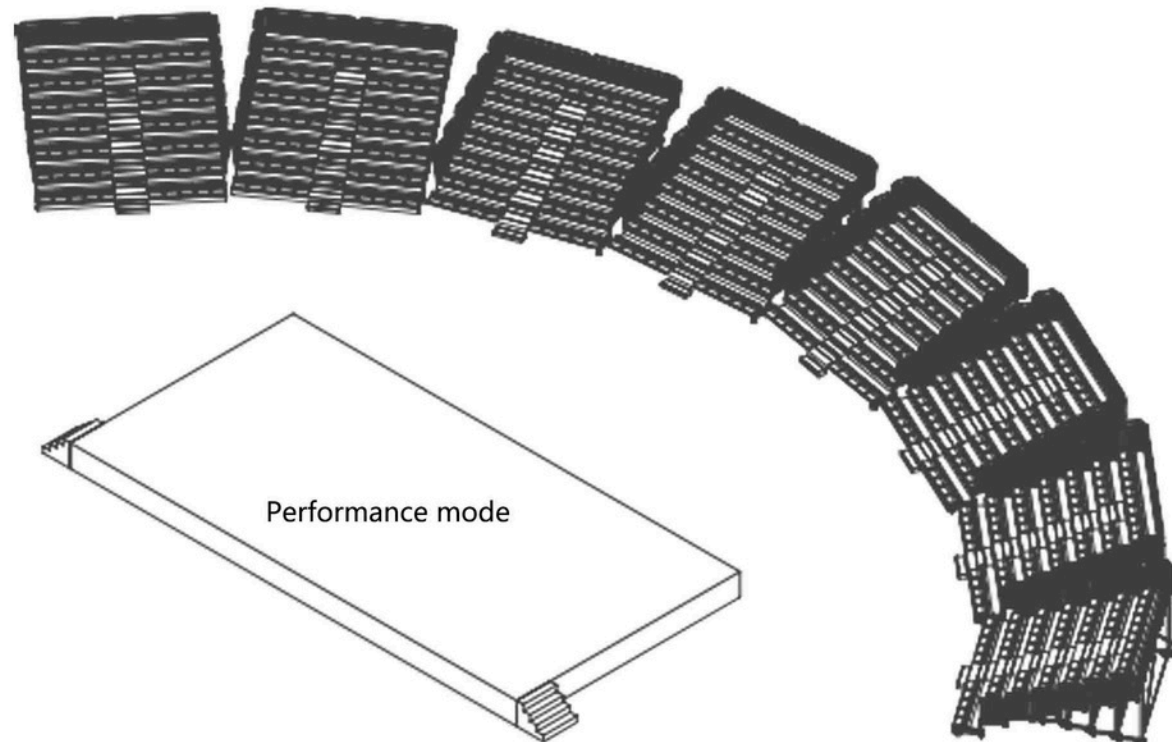
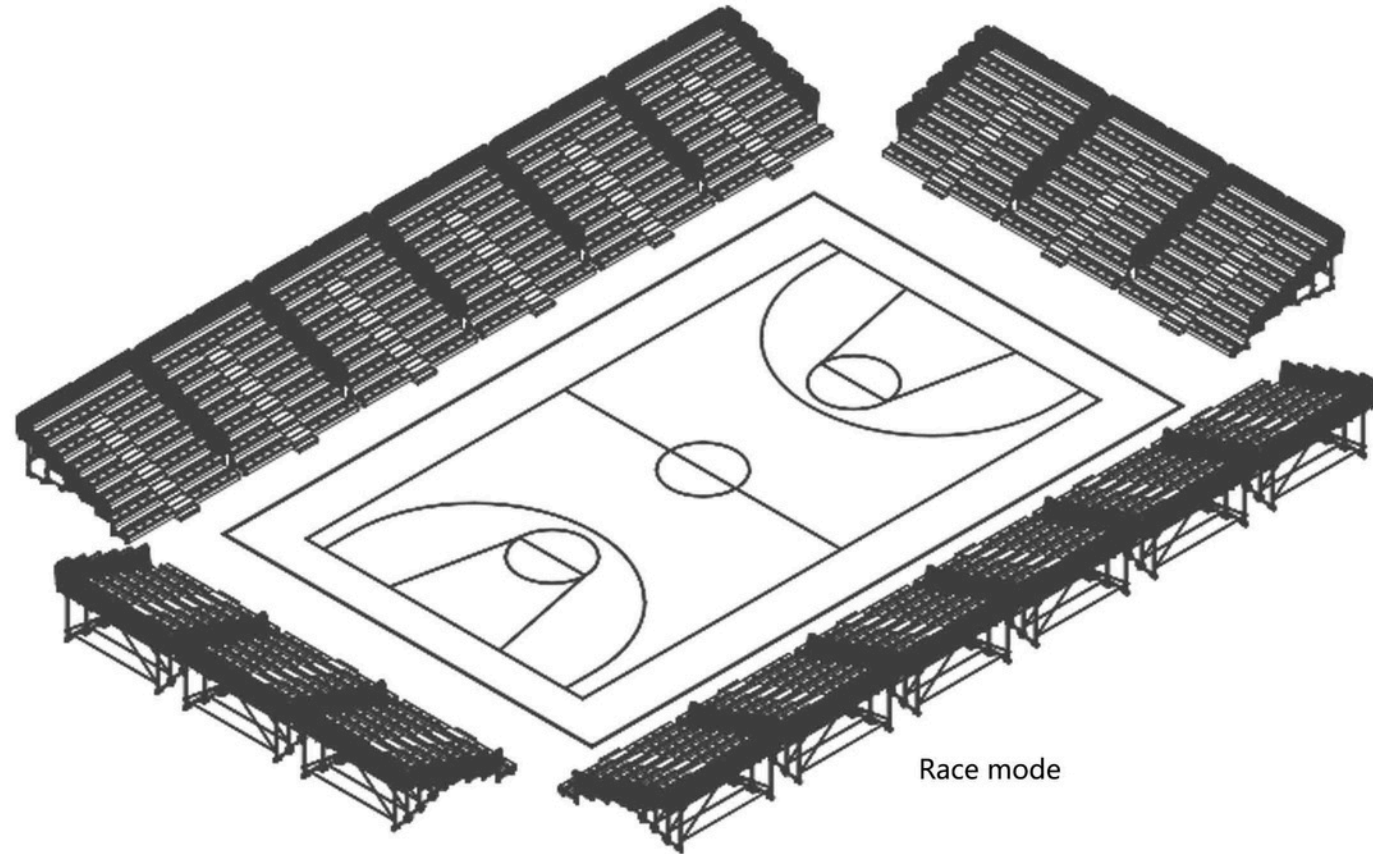

Single set of size drawings

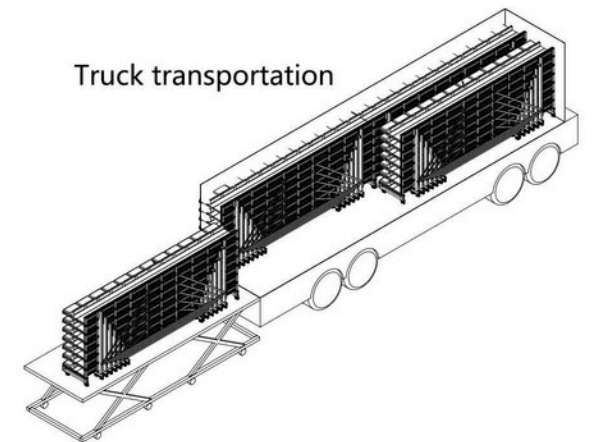
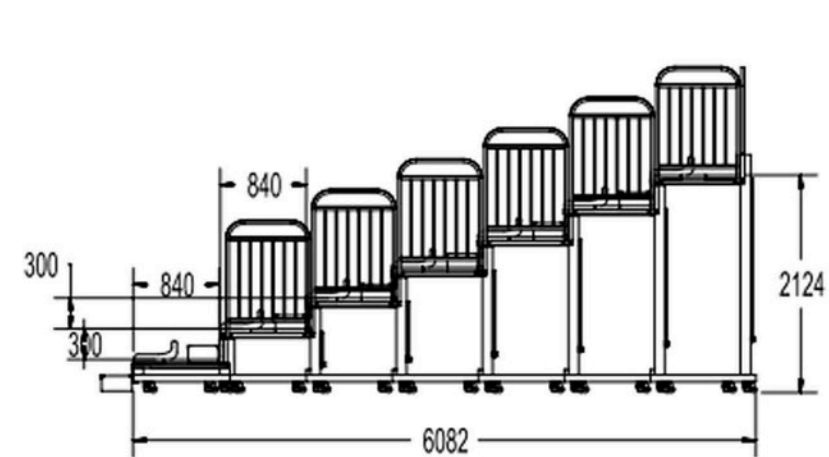
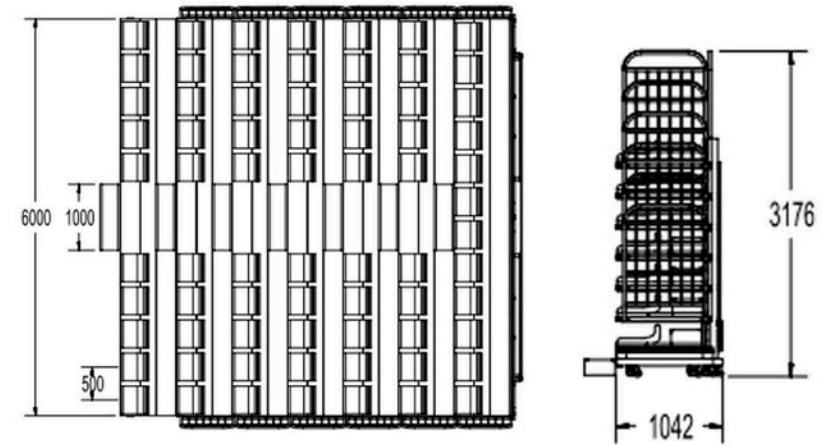

- 360° movable retractble bleachers
- ▶ Model:BL-STE-08-CB
- ▶ Metal Treatments:Powder Coating
- ▶ Pedal: 18 mm melamine multilayer plywood
- ▶ Loading Capacity:≥5KN per square meters
- ▶ Guard Rail:3 Side safety Rail
- ▶ Aisles:1 meters width
- ▶ Applications:Indoor basketball court
- ▶ Structure Pillars: 50x100x3.5mm
- ▶ Beam:50x220x3mm
- ▶ Telescopic Mode: Manual
- ▶ Rows:8 (Customized size accepted)
- ▶ Row Depth:900mm
- ▶ Row Rise:300mm
- ▶ Seating Capacity:58
- ▶ Seats C/C:500mm
- ▶ L/W/H:4500x7200x3500mm
- ▶ Seats Materail:Stamped steel bracket, environmentally friendly sheet, fireproof fabric, high-density cold foam polyurethane molding foam
- ▶ Design Standard:EN-13200

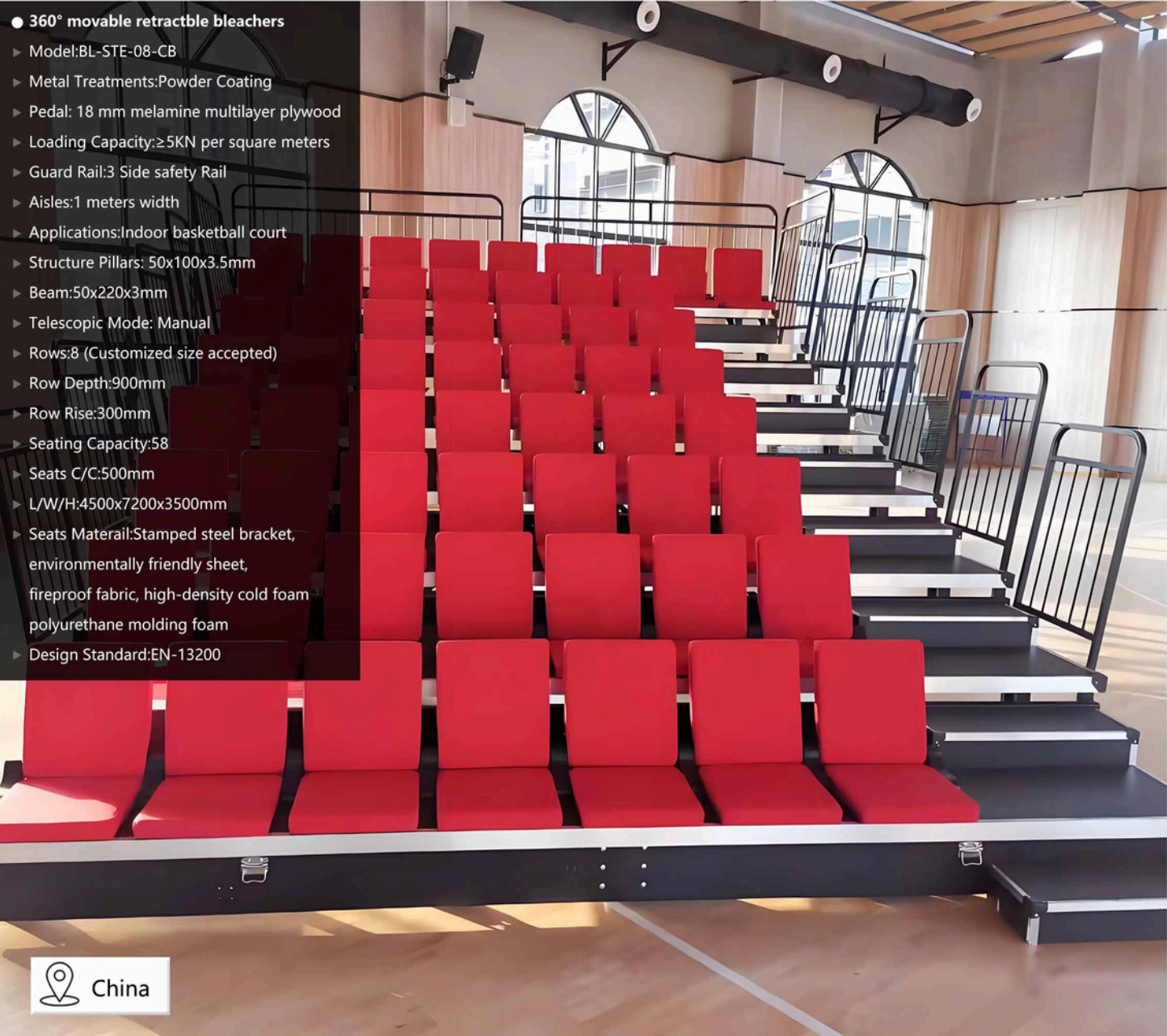

China

- 360° movable retractble bleachers
- ▶ Model:BL-STE-08-CA
- ▶ Metal Treatments:Powder Coating
- ▶ Pedal: 18 mm melamine multilayer plywood
- ▶ Loading Capacity:≥5KN per square meters
- ▶ Guard Rail:3 Side safety Rail
- ▶ Aisles:1 meters width
- ▶ Structure Pillars: 50x100x3.5mm
- ▶ Beam:50x220x3mm
- ▶ Telescopic Mode: Manual
- ▶ Rows:4 (Customized size accepted)
- ▶ Row Depth:800mm
- ▶ Row Rise:300mm
- ▶ Seating Capacity:34
- ▶ Seats C/C:500mm
- ▶ L/W/H:5000x2800x2300mm
- ▶ Seats Materail:HDPE
- ▶ Applications:Indoor basketball court
- ▶ Design Standard:EN-13200

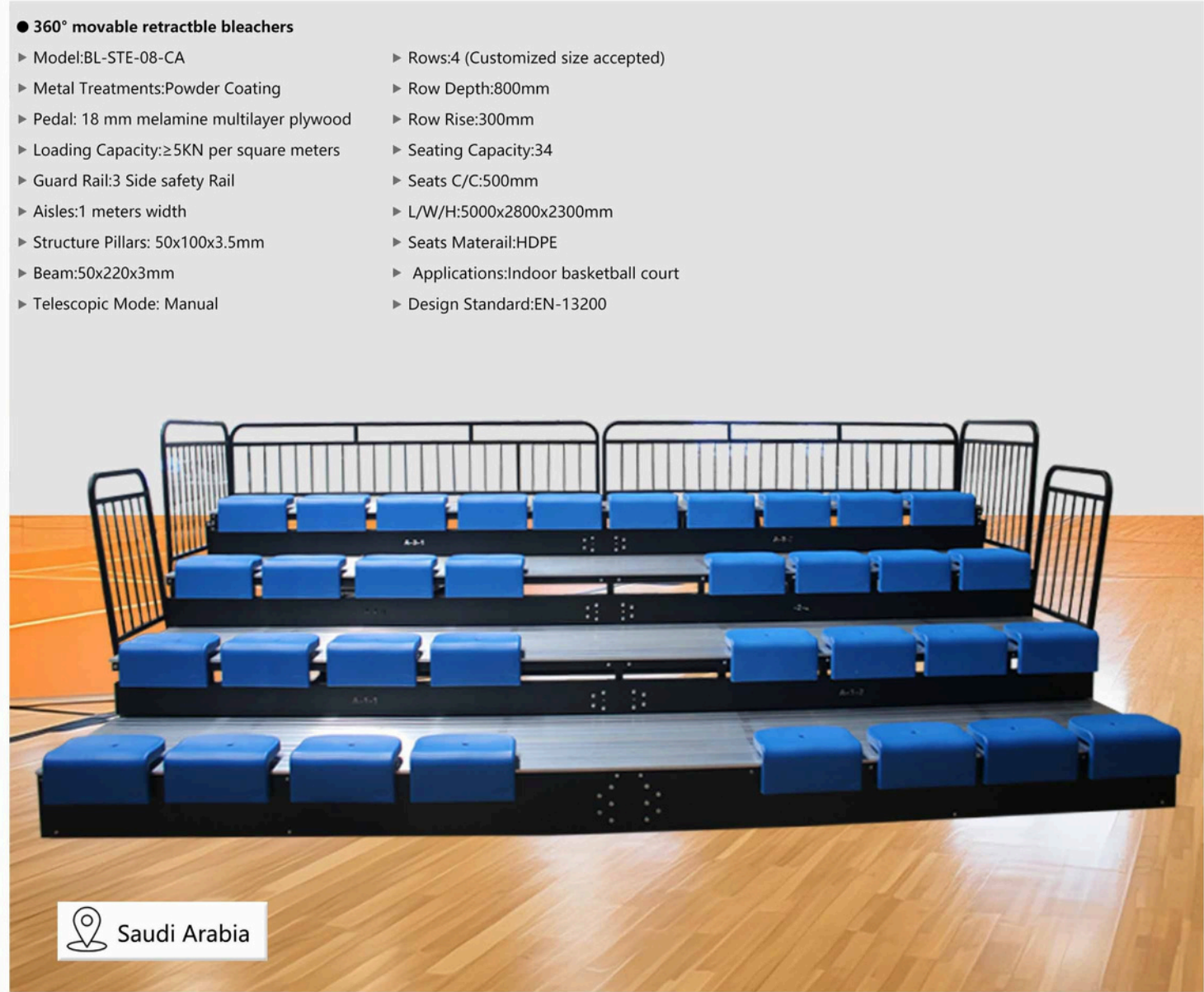

Saudi Arabia



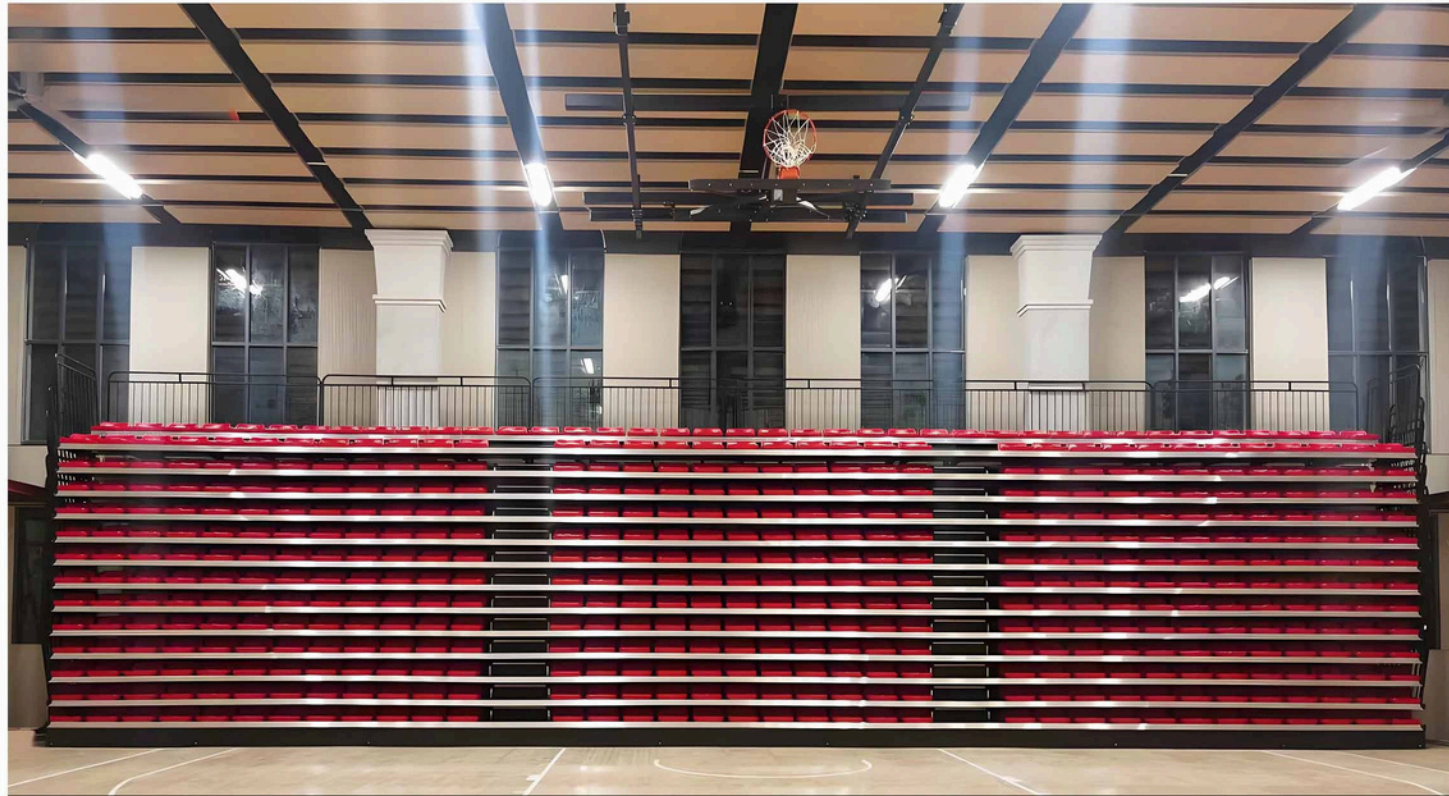

● Retractable Bleachers Low back Rest Seats

- ▶ Model:BL-STE-14-CE
- ▶ Metal Treatments:Powder Coating
- ▶ Pedal: 18 mm melamine multilayer plywood
- ▶ Loading Capacity:≥5KN per square meters
- ▶ Guard Rail:3 Side safety Rail
- ▶ Aisles:1 meters width
- ▶ Applications:Multifunctional hall
- ▶ Structure Pillars: 50x100x3.5mm
- ▶ Beam:50x220x3mm
- ▶ Rows:14 (Customized size accepted)
- ▶ Row Depth:800mm
- ▶ Row Rise:300mm
- ▶ Seating Capacity:494
- ▶ Seats C/C:460mm
- ▶ L/W/H:18x11.2x5.3m
- ▶ Seats Material:HDPE
- ▶ Telescopic Mode: Electric
- ▶ Design Standard:EN-13200

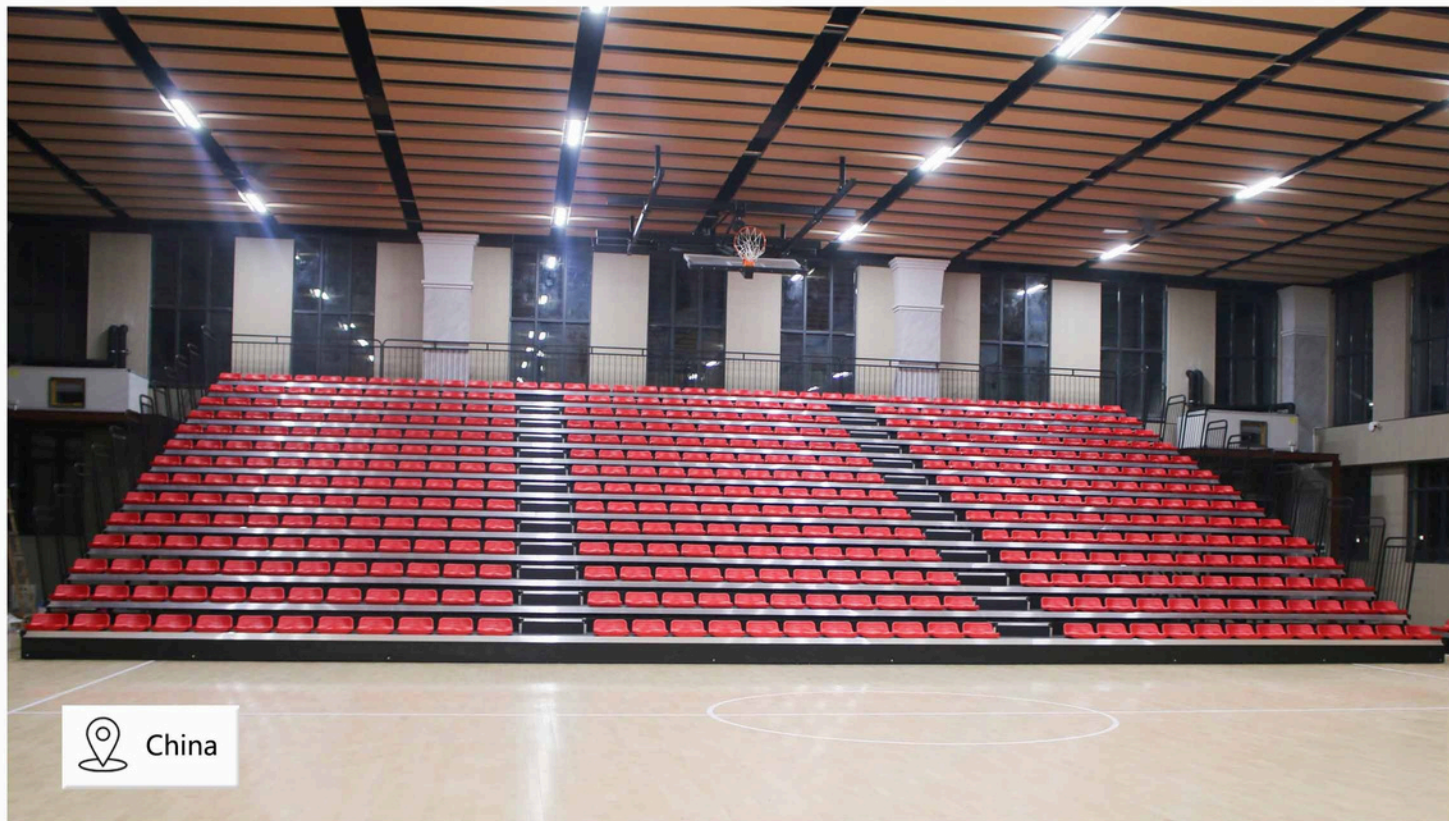

China

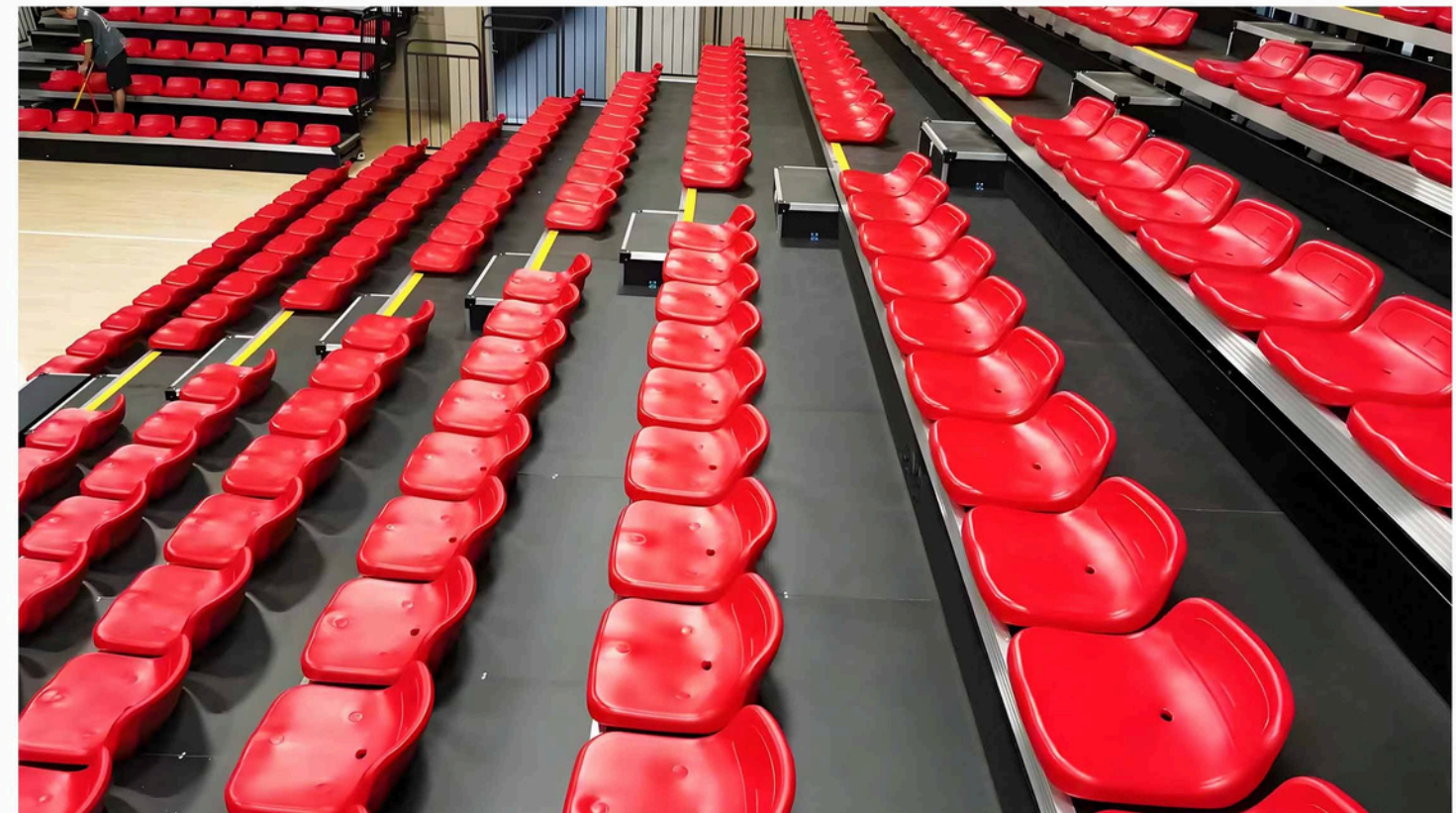

● Retractable Bleachers Low back Rest Seats

- ▶ Model:BL-STE-05-CE
- ▶ Metal Treatments:Powder Coating
- ▶ Pedal: 18 mm melamine multilayer plywood
- ▶ Loading Capacity:≥5KN per square meters
- ▶ Guard Rail:3 Side safety Rail
- ▶ Aisles:1 meters width
- ▶ Applications:Indoor basketball court
- ▶ Structure Pillars: 50x100x3.5mm
- ▶ Beam:50x220x3mm
- ▶ Telescopic Mode: Manual
- ▶ Rows:5 (Customized size accepted)
- ▶ Row Depth:800mm
- ▶ Row Rise:300mm
- ▶ Seating Capacity:268
- ▶ Seats C/C:480mm
- ▶ L/W/H:30000x3702x2422mm
- ▶ Seats Materail:HDPE
- ▶ Design Standard:EN-13200

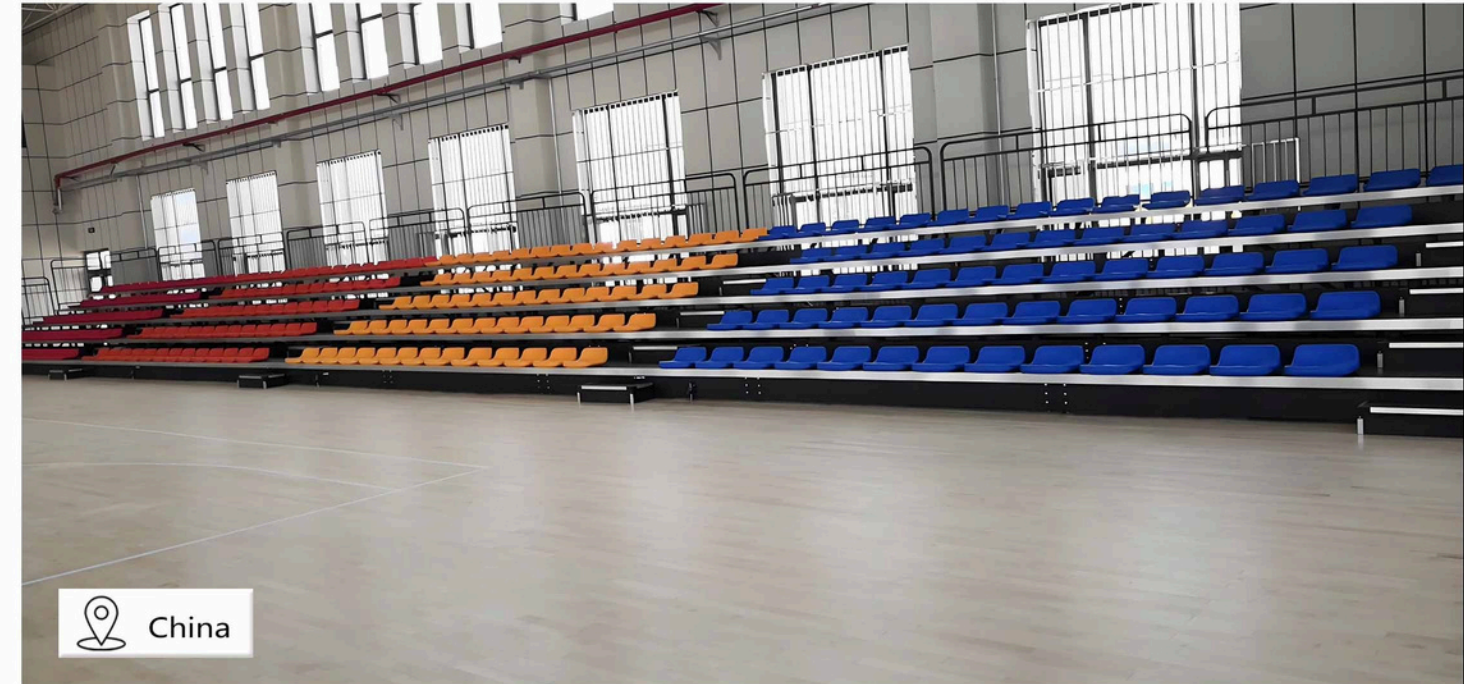
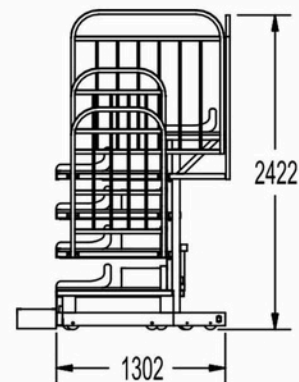
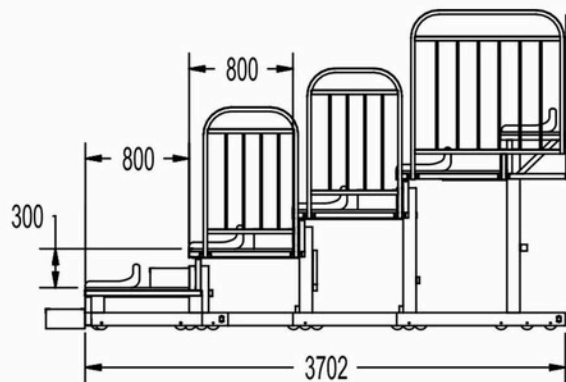
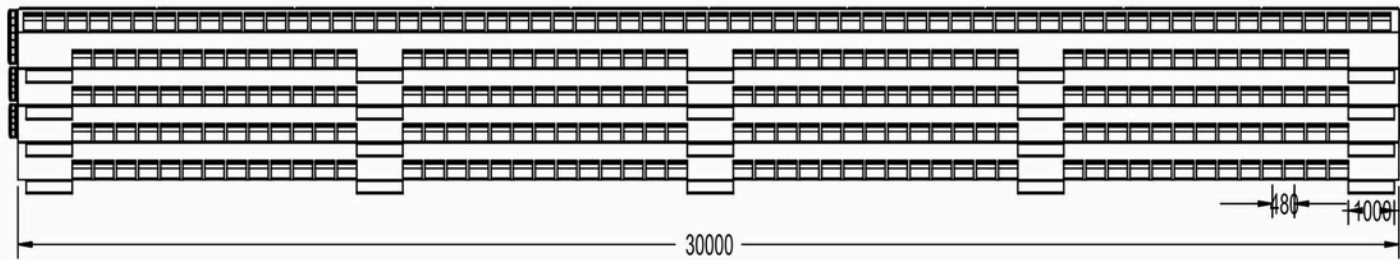
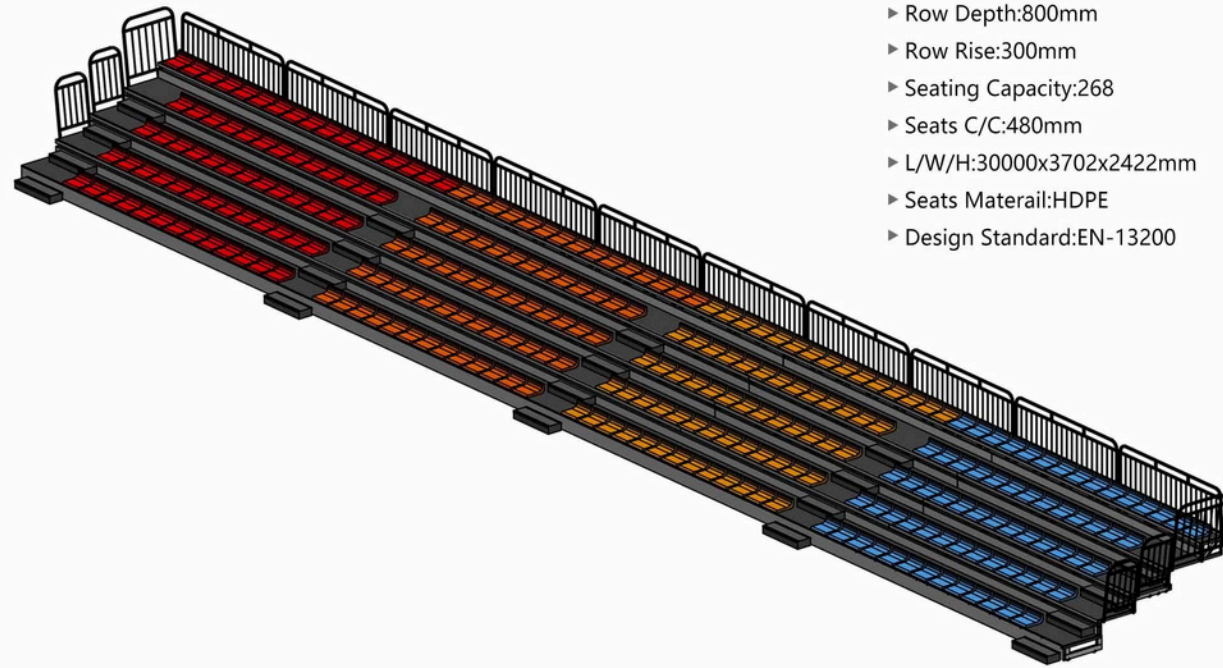

China

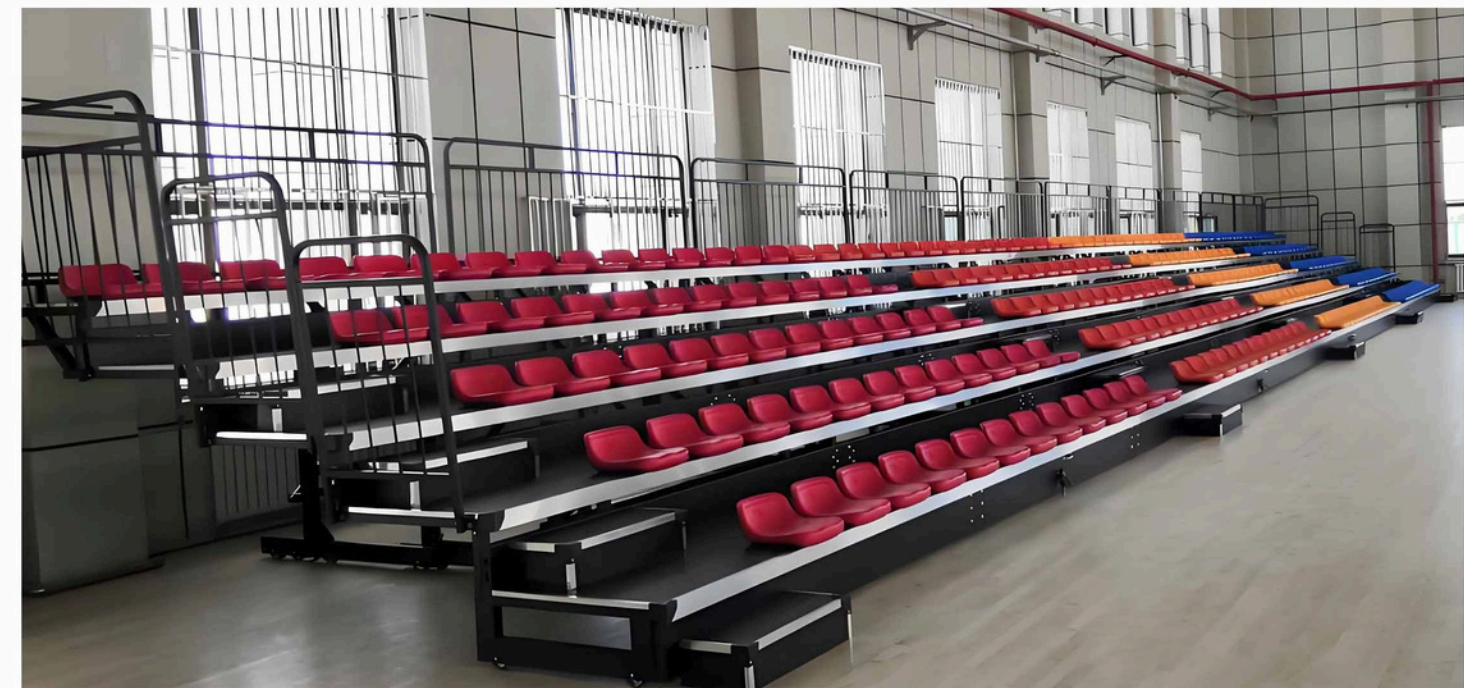
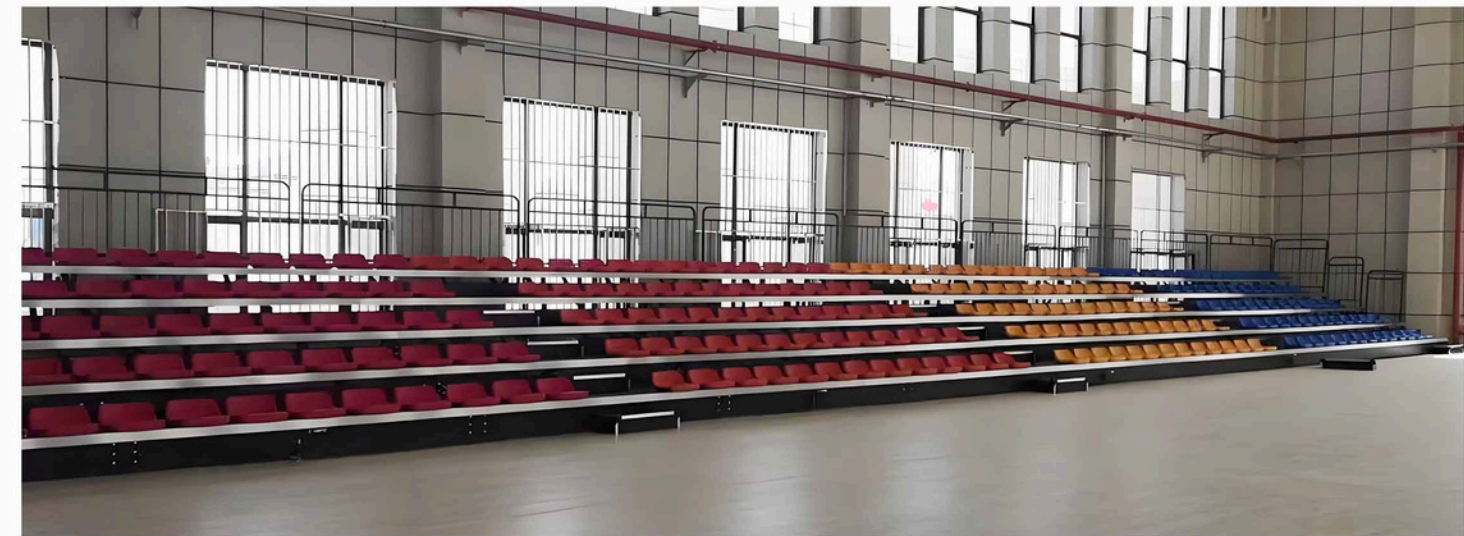



● Retractable Bleachers Low back Rest Seats

- ▶ Model:BL-STE-07-CE
- ▶ Metal Treatments:Powder Coating
- ▶ Pedal: 18 mm melamine multilayer plywood
- ▶ Loading Capacity:≥5KN per square meters
- ▶ Guard Rail:3 Side safety Rail
- ▶ Aisles:1 meters width
- ▶ Structure Pillars: 50x100x3.5mm
- ▶ Beam:50x220x3mm
- ▶ Telescopic Mode: Electric
- ▶ Rows:7 (Customized size accepted)
- ▶ Row Depth:750mm
- ▶ Row Rise:300mm
- ▶ Seating Capacity:400
- ▶ Seats C/C:500mm
- ▶ L/W/H:26000x5250x3200mm
- ▶ Seats Material:HDPE
- ▶ Applications:Indoor basketball court
- ▶ Design Standard:EN-13200



China



● Retractable Bleachers Low back Rest Seats

- ▶ Model:BL-STE-09-CE
- ▶ Metal Treatments:Powder Coating
- ▶ Pedal: 18 mm melamine multilayer plywood
- ▶ Loading Capacity:≥5KN per square meters
- ▶ Guard Rail:3 Side safety Rail
- ▶ Aisles:1 meters width
- ▶ Applications:Indoor basketball court
- ▶ Structure Pillars: 50x100x3.5mm
- ▶ Beam:50x220x3mm
- ▶ Telescopic Mode: Manual
- ▶ Rows:9 (Customized size accepted)
- ▶ Row Depth:800mm
- ▶ Row Rise:300mm
- ▶ Seating Capacity:465
- ▶ Seats C/C:450mm
- ▶ L/W/H:26000x6902x3720mm
- ▶ Seats Material:HDPE
- ▶ Design Standard:EN-13200

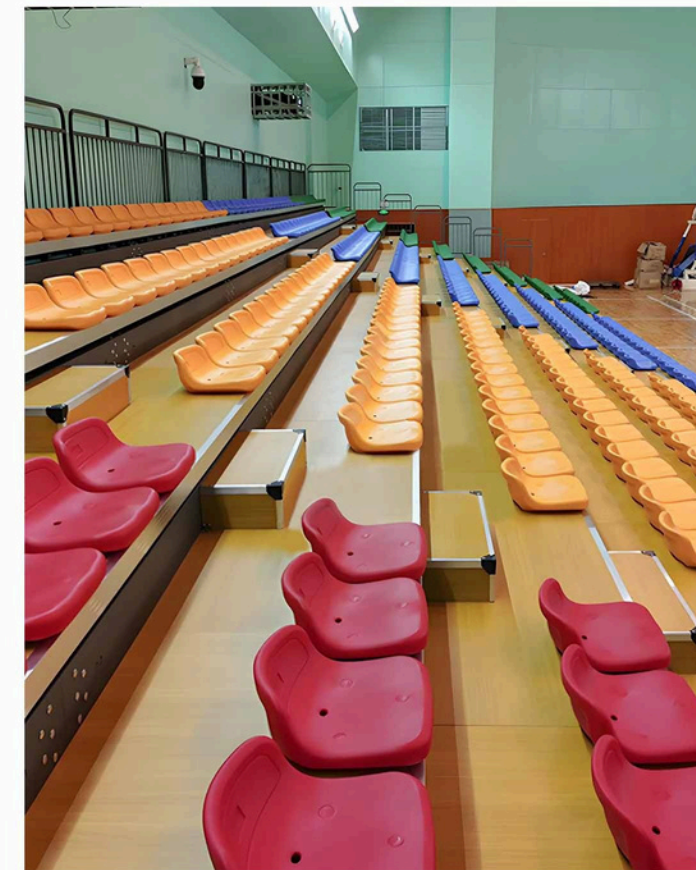
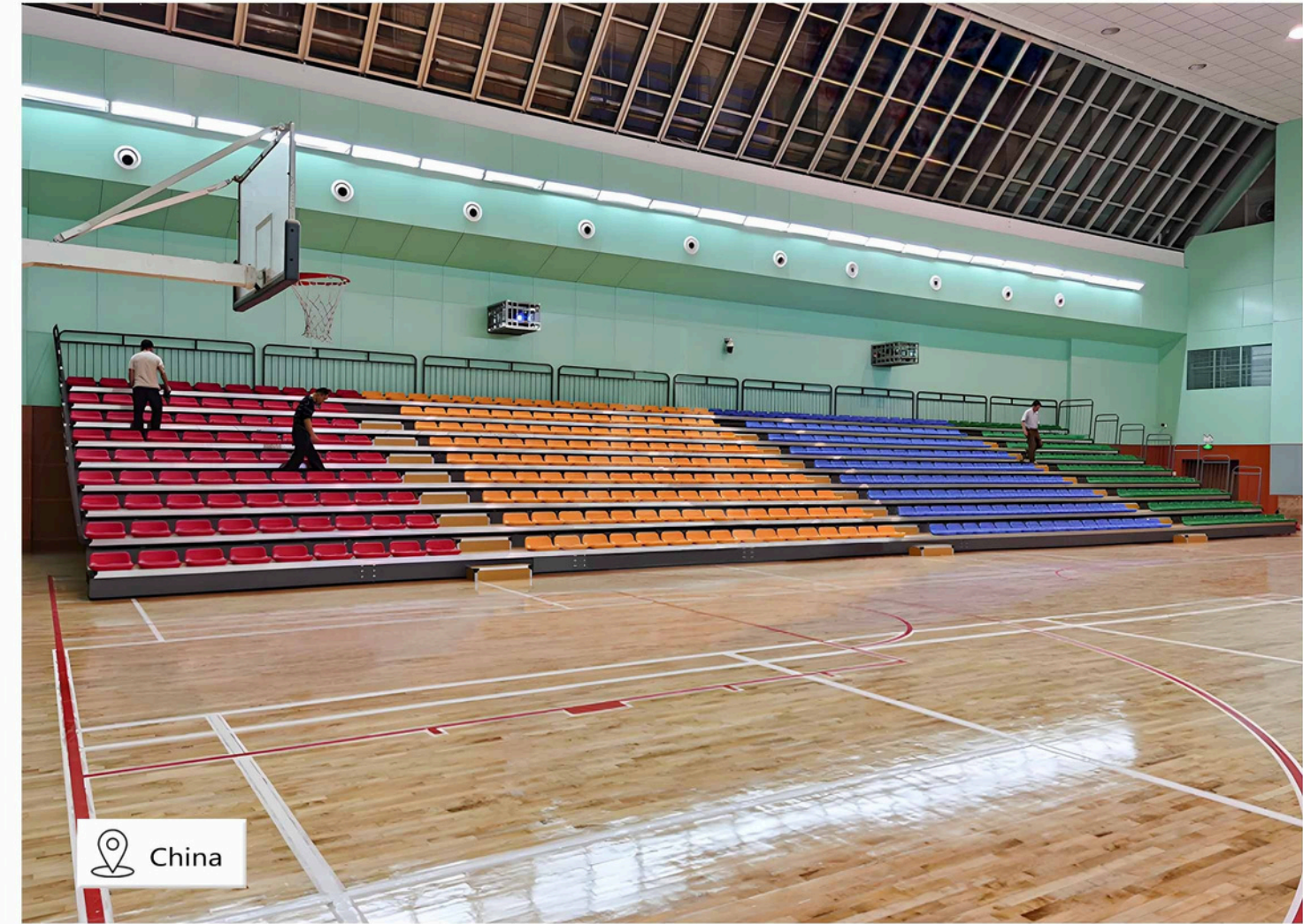
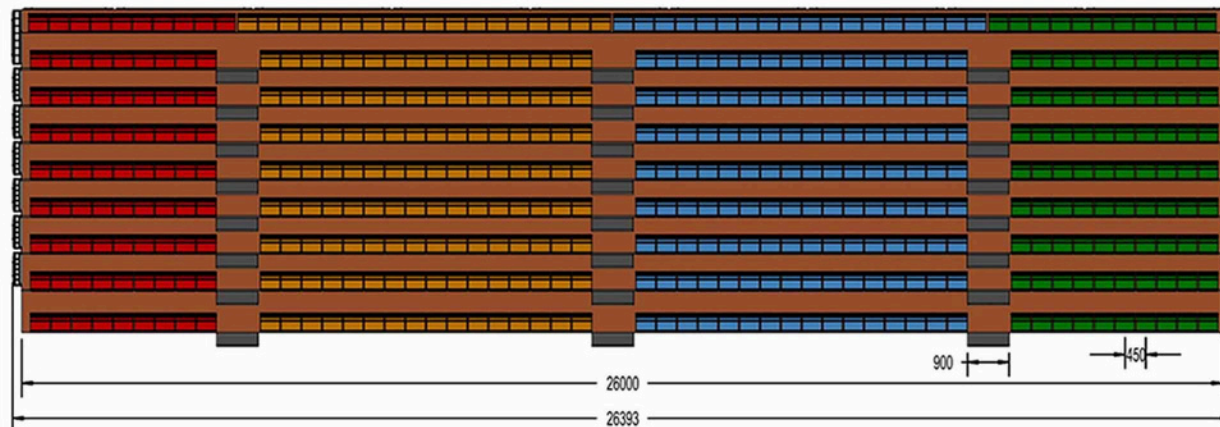
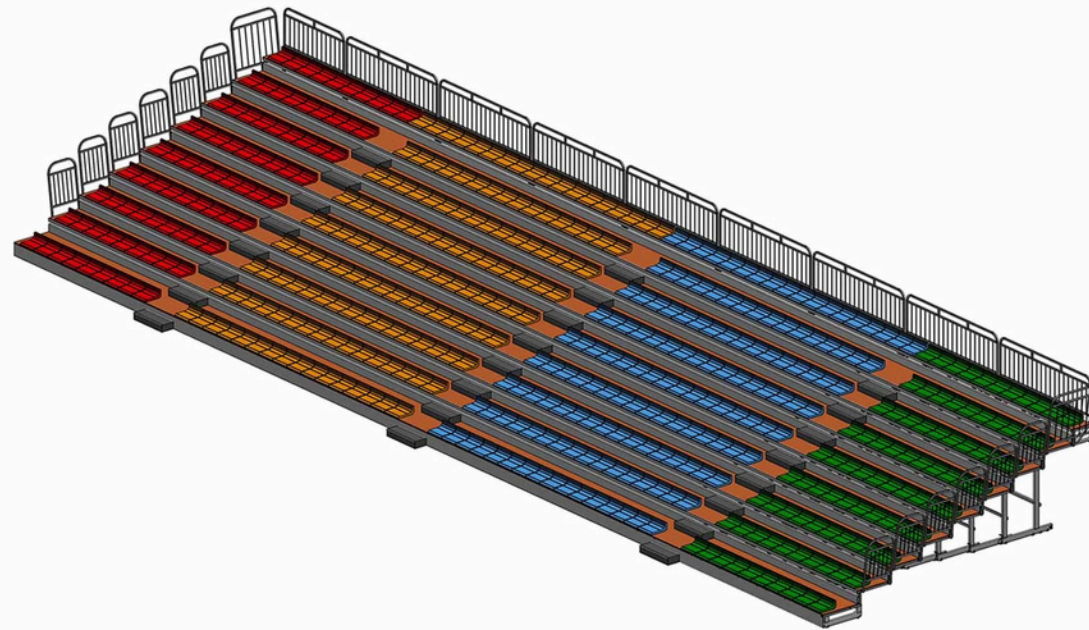
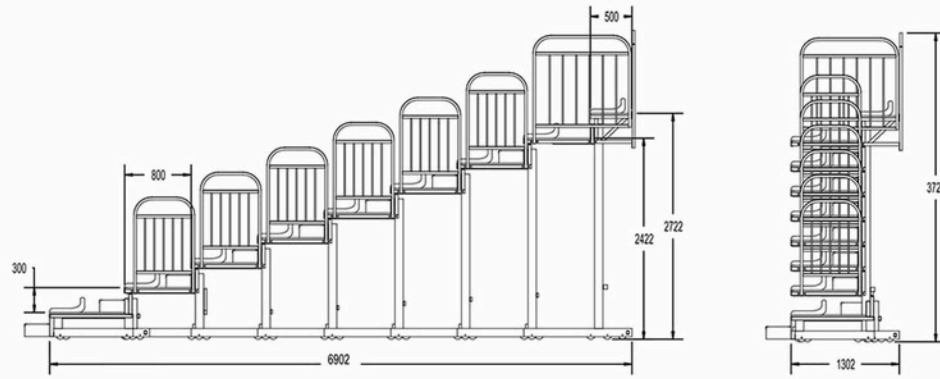

● Retractable Bleachers Low back Rest Seats

- ▶ Model:BL-STE-07-CE
- ▶ Metal Treatments:Powder Coating
- ▶ Pedal: 18 mm melamine multilayer plywood
- ▶ Loading Capacity:≥5KN per square meters
- ▶ Guard Rail:3 Side safety Rail
- ▶ Aisles:1 meters width
- ▶ Applications:Indoor basketball court
- ▶ Structure Pillars: 50x100x3.5mm
- ▶ Beam:50x220x3mm
- ▶ Telescopic Mode: Manual
- ▶ Rows:7 (Customized size accepted)
- ▶ Row Depth:800mm
- ▶ Row Rise:300mm
- ▶ Seating Capacity:370
- ▶ Seats C/C:450mm
- ▶ L/W/H:27000x5302x3058mm
- ▶ Seats Materail:HDPE
- ▶ Design Standard:EN-13200

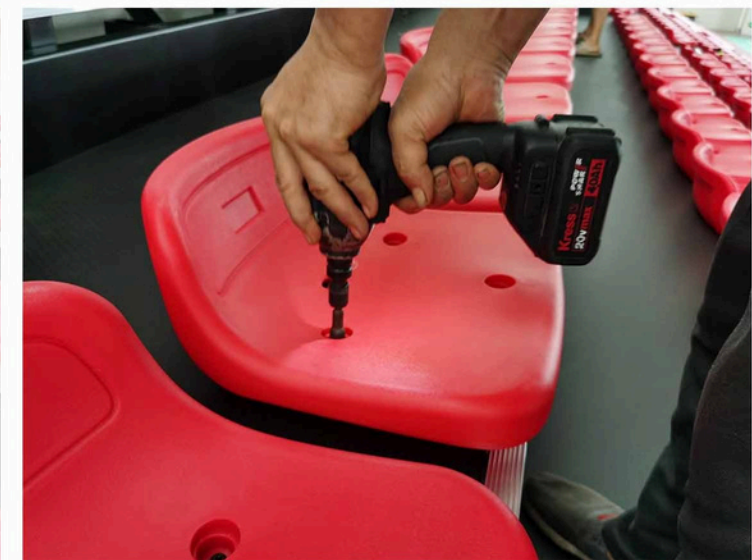
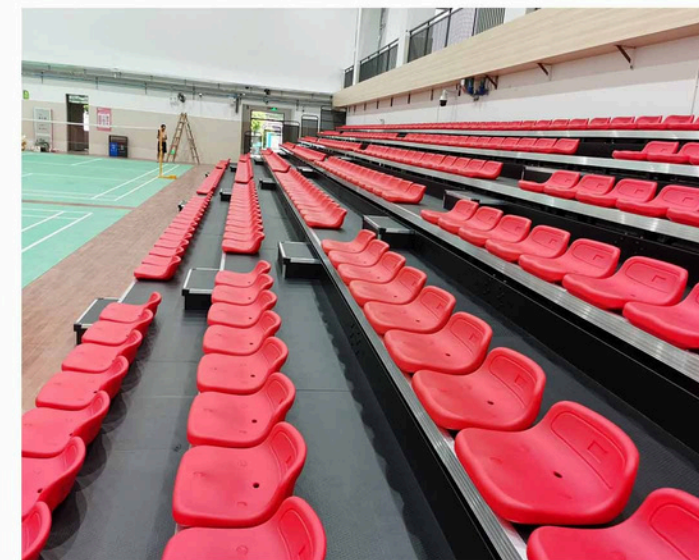
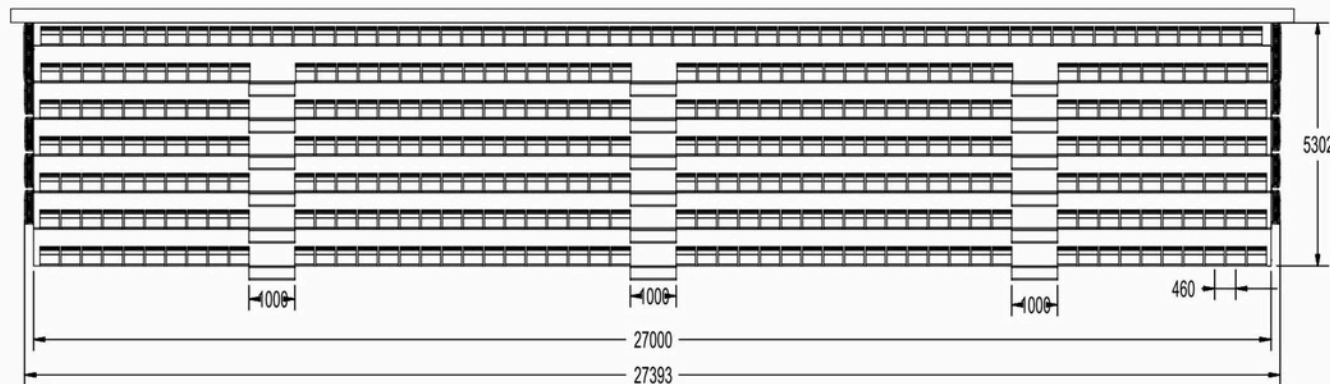
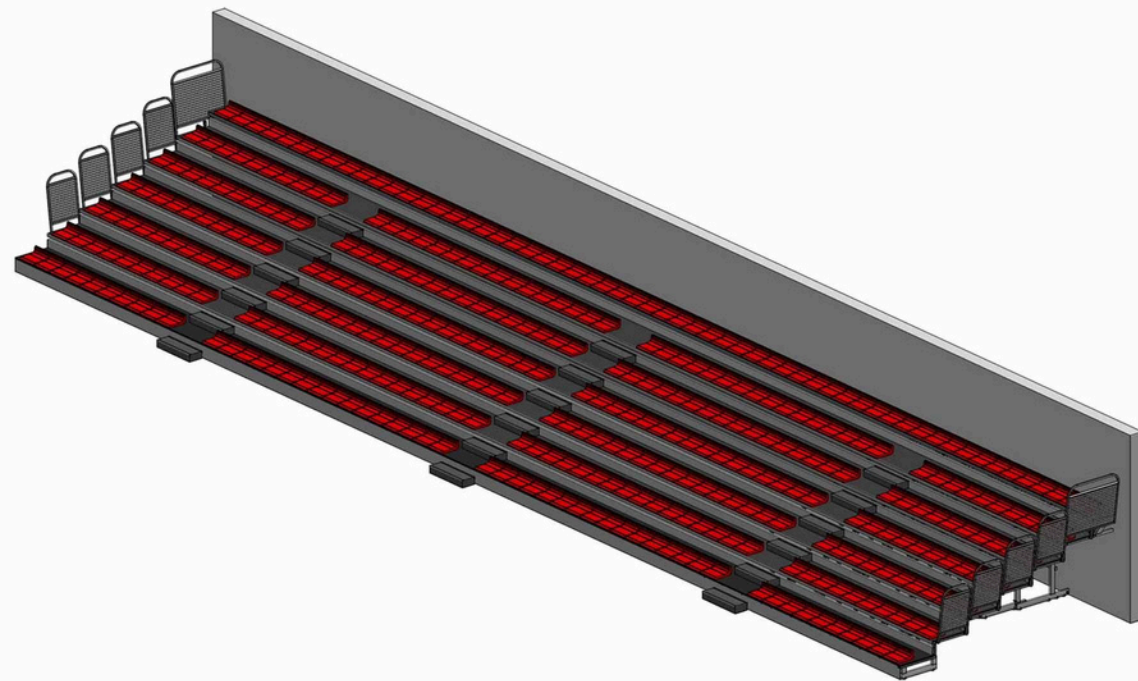
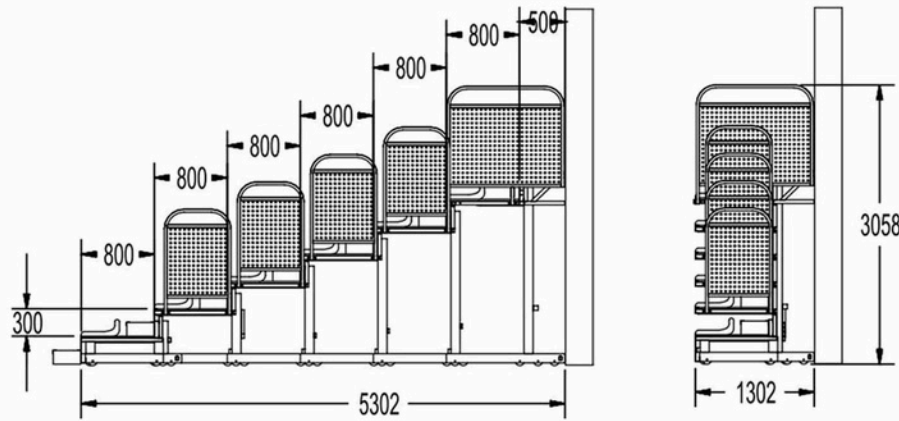



● Retractable Bleachers Low back Rest Seats

- ▶ Model:BL-STE-10-CE
- ▶ Metal Treatments:Powder Coating
- ▶ Pedal: 18 mm melamine multilayer plywood
- ▶ Loading Capacity:≥5KN per square meters
- ▶ Guard Rail:3 Side safety Rail
- ▶ Aisles:1 meters width
- ▶ Structure Pillars: 50x100x3.5mm
- ▶ Beam:50x220x3mm
- ▶ Telescopic Mode: Electric
- ▶ Rows:10 (Customized size accepted)
- ▶ Row Depth:750mm
- ▶ Row Rise:300mm
- ▶ Seating Capacity:204
- ▶ Seats C/C:500mm
- ▶ L/W/H:12000x7500x4100mm
- ▶ Seats Material:HDPE
- ▶ Applications:Indoor basketball court
- ▶ Design Standard:EN-13200



● Retractable Bleachers Foldable Corner Seats

- ▶ Model: BL-STE-07-CA
- ▶ Metal Treatments: Powder Coating
- ▶ Pedal: 18 mm melamine multilayer plywood
- ▶ Loading Capacity: ≥5KN per square meters
- ▶ Guard Rail: 2 Side safety Rail
- ▶ Aisles: 1 meters width
- ▶ Applications: Indoor basketball court
- ▶ Structure Pillars: 50x100x3.5mm
- ▶ Beam: 50x220x3mm
- ▶ Telescopic Mode: Electric
- ▶ Rows: 7 (Customized size accepted)
- ▶ Row Depth: 850mm
- ▶ Row Rise: 300mm
- ▶ Seating Capacity: 384
- ▶ Seats C/C: 500mm
- ▶ L/W/H: 30000x6252x2290mm
- ▶ Seats Material: HDPE
- ▶ Design Standard: EN-13200

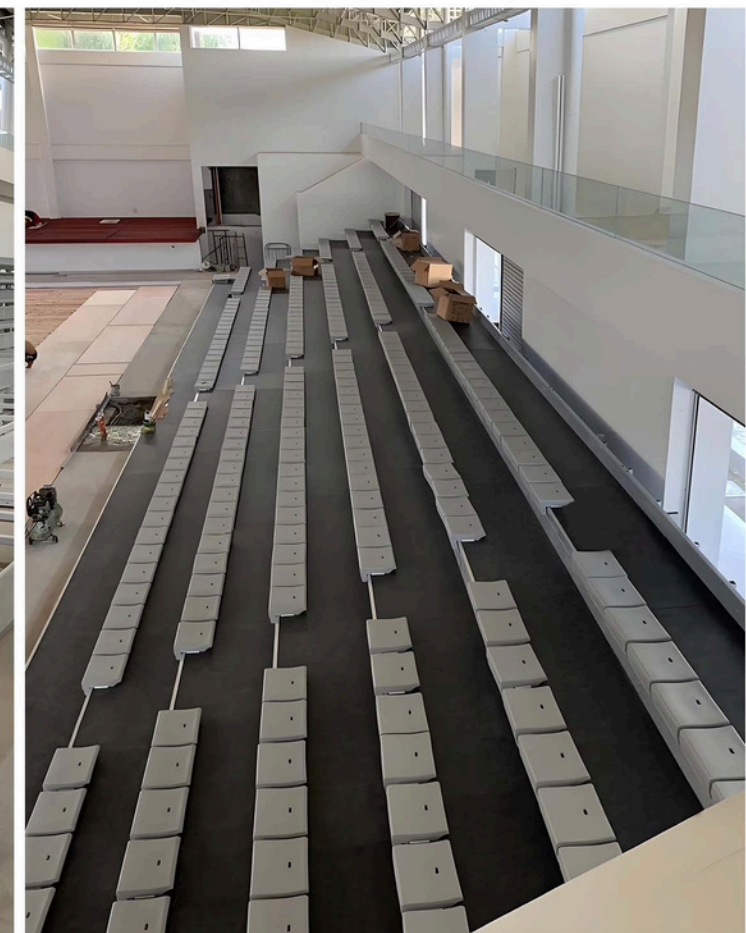
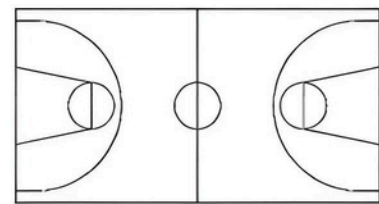
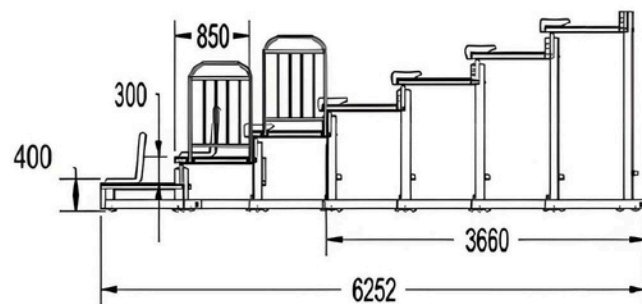
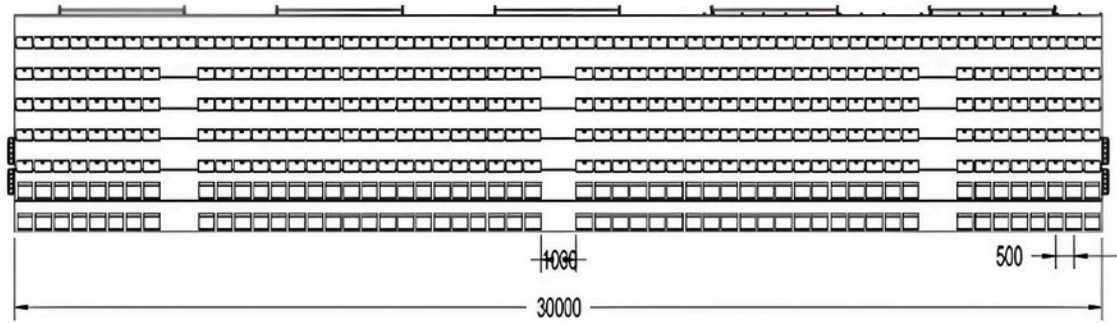
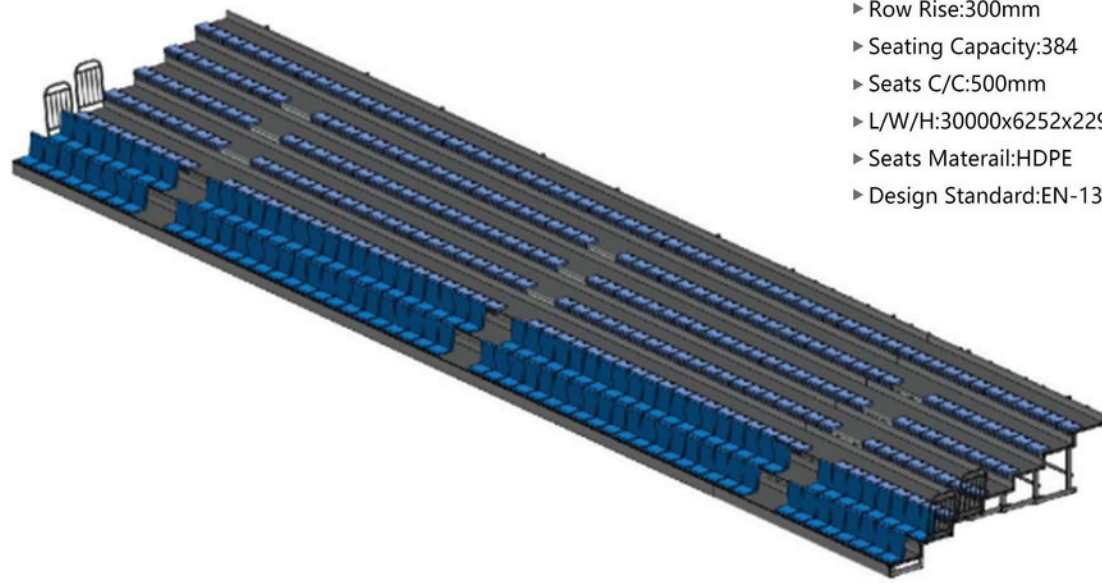
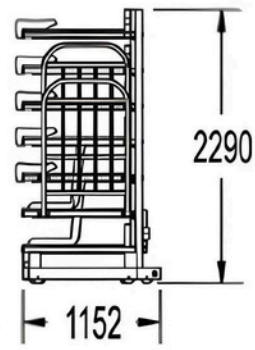

● Retractable Bleachers Foldable Corner Seats

- ▶ Model:BL-STE-06-CA
- ▶ Metal Treatments:Powder Coating
- ▶ Pedal: 18 mm melamine multilayer plywood
- ▶ Loading Capacity:≥5KN per square meters
- ▶ Guard Rail:3 Side safety Rail
- ▶ Aisles:1 meters width
- ▶ Applications:Indoor basketball court
- ▶ Structure Pillars: 50x100x3.5mm
- ▶ Beam:50x220x3mm
- ▶ Telescopic Mode: Manual
- ▶ Rows:6 (Customized size accepted)
- ▶ Row Depth:800mm
- ▶ Row Rise:300mm
- ▶ Seating Capacity:116
- ▶ Seats C/C:500mm
- ▶ L/W/H:10500x4502x2880mm
- ▶ Seats Materail:HDPE
- ▶ Design Standard:EN-13200

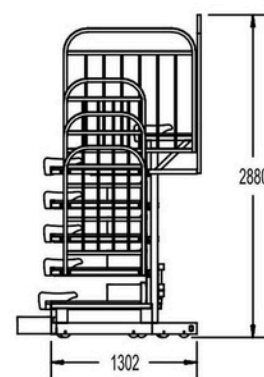
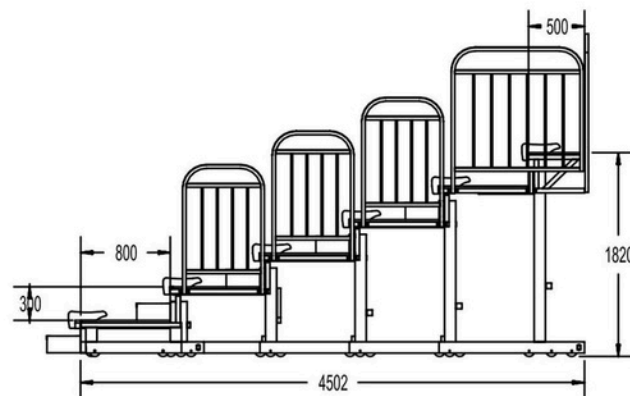
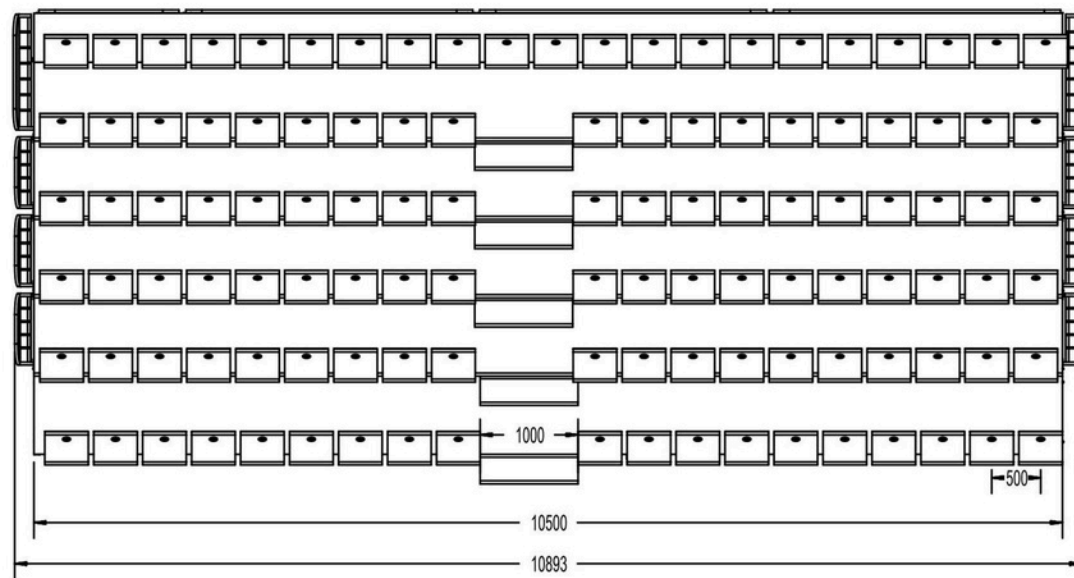
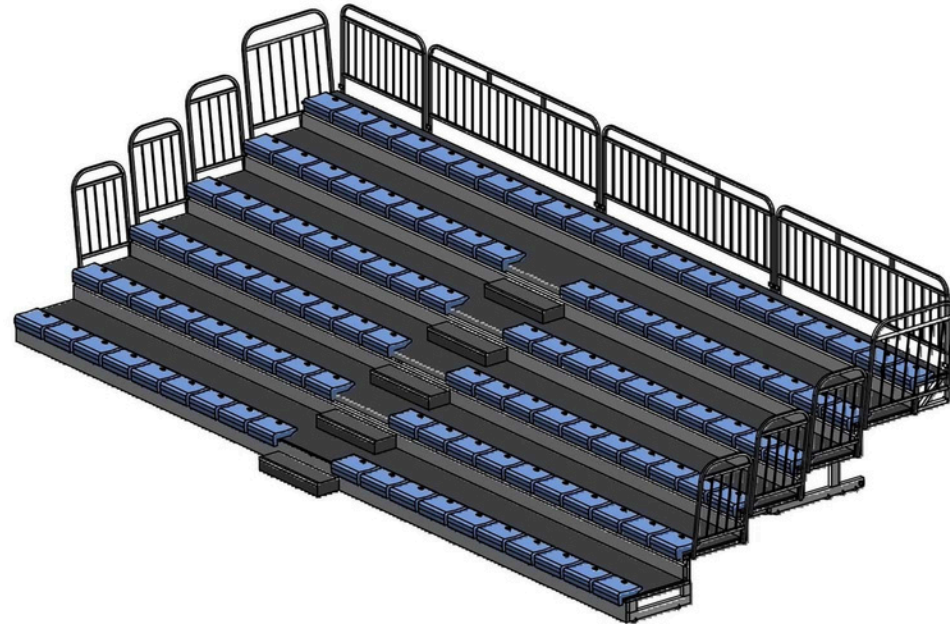

● Retractable Bleachers Foldable Corner Seats

- ▶ Model:BL-STE-05-CA
- ▶ Metal Treatments:Powder Coating
- ▶ Pedal: 18 mm melamine multilayer plywood
- ▶ Loading Capacity:≥5KN per square meters
- ▶ Guard Rail:2 Side safety Rail
- ▶ Aisles:1.25 meters width
- ▶ Applications:Multifunctional hall
- ▶ Structure Pillars: 50x100x3.5mm
- ▶ Beam:50x220x3mm
- ▶ Telescopic Mode: Electric
- ▶ Rows:5 (Customized size accepted)
- ▶ Row Depth:705mm
- ▶ Row Rise:300mm
- ▶ Seating Capacity:206
- ▶ Seats C/C:430mm
- ▶ L/W/H:21000x3525x2432mm
- ▶ Seats Materail:HDPE
- ▶ Design Standard:EN-13200

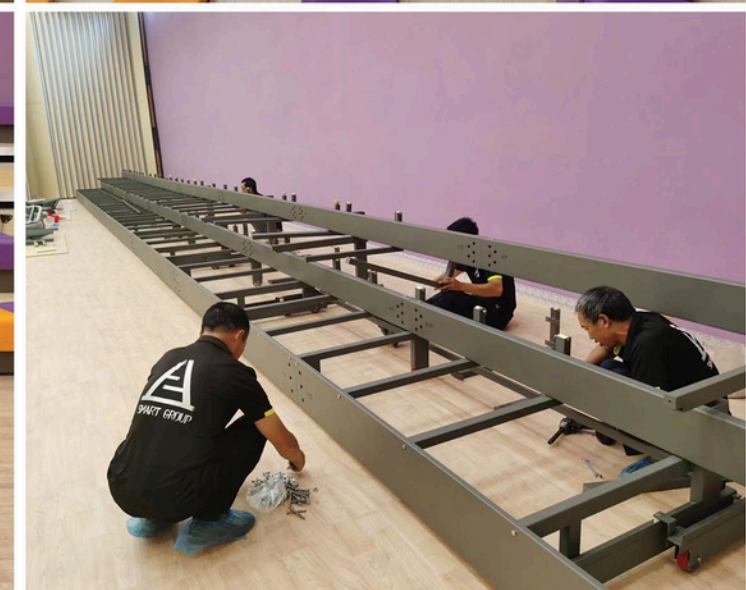
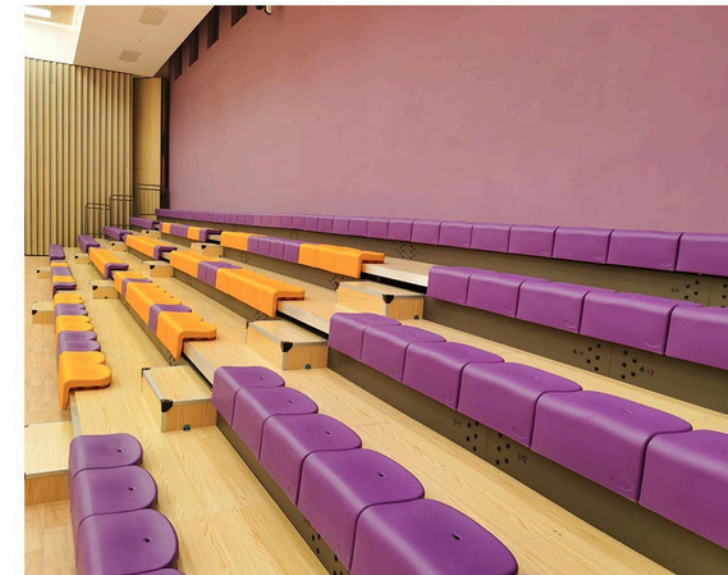
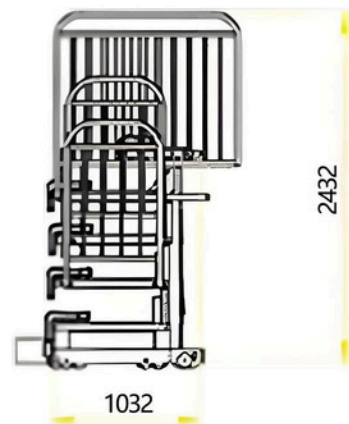
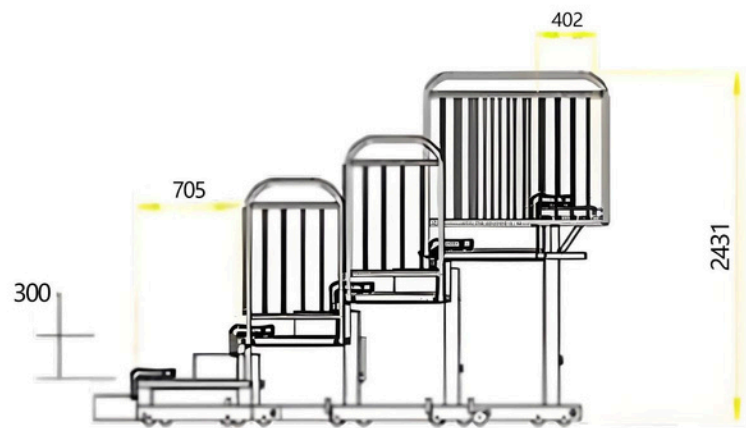
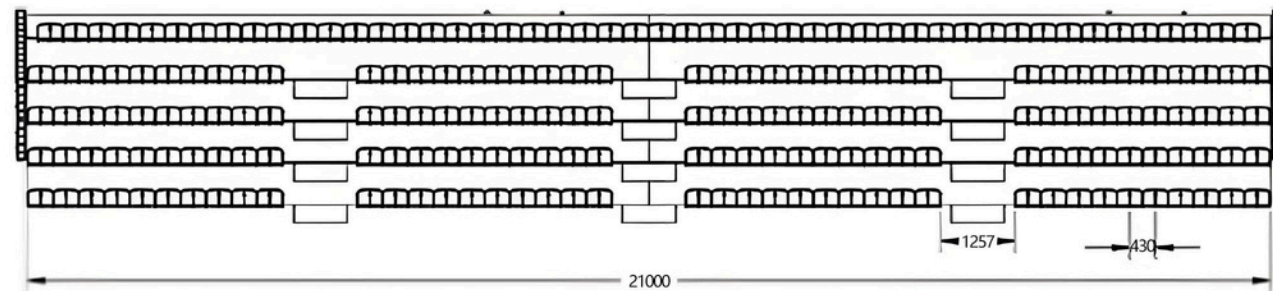
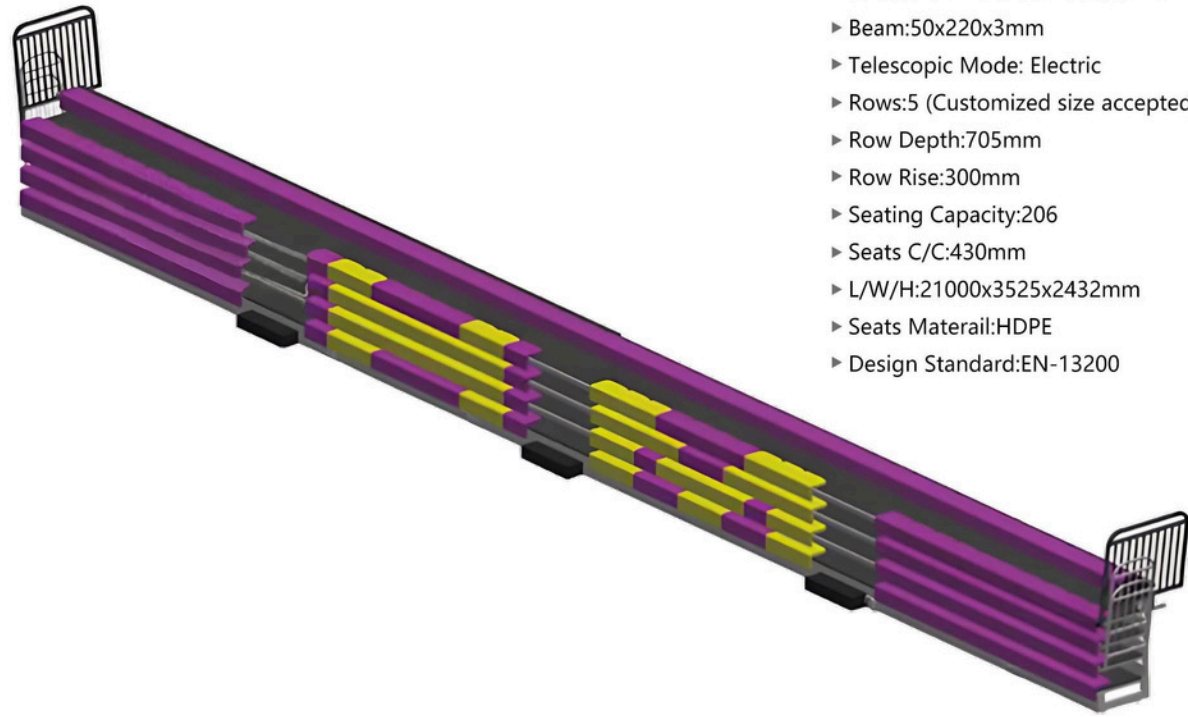

● Retractable Bleachers Foldable Corner Seats

- ▶ Model:BL-STE-03-CA
- ▶ Metal Treatments:Powder Coating
- ▶ Pedal: 18 mm melamine multilayer plywood
- ▶ Loading Capacity:≥5KN per square meters
- ▶ Guard Rail:3 Side safety Rail
- ▶ Aisles:0.78 meters width
- ▶ Applications:School gymnasium
- ▶ Structure Pillars: 50x100x3.5mm
- ▶ Beam:50x220x3mm
- ▶ Telescopic Mode: Electric
- ▶ Rows:3 (Customized size accepted)
- ▶ Row Depth:700mm
- ▶ Row Rise:300mm
- ▶ Seating Capacity:24
- ▶ Seats C/C:480mm
- ▶ L/W/H:4730x2252x1522mm
- ▶ Seats Materail:HDPE
- ▶ Design Standard:EN-13200

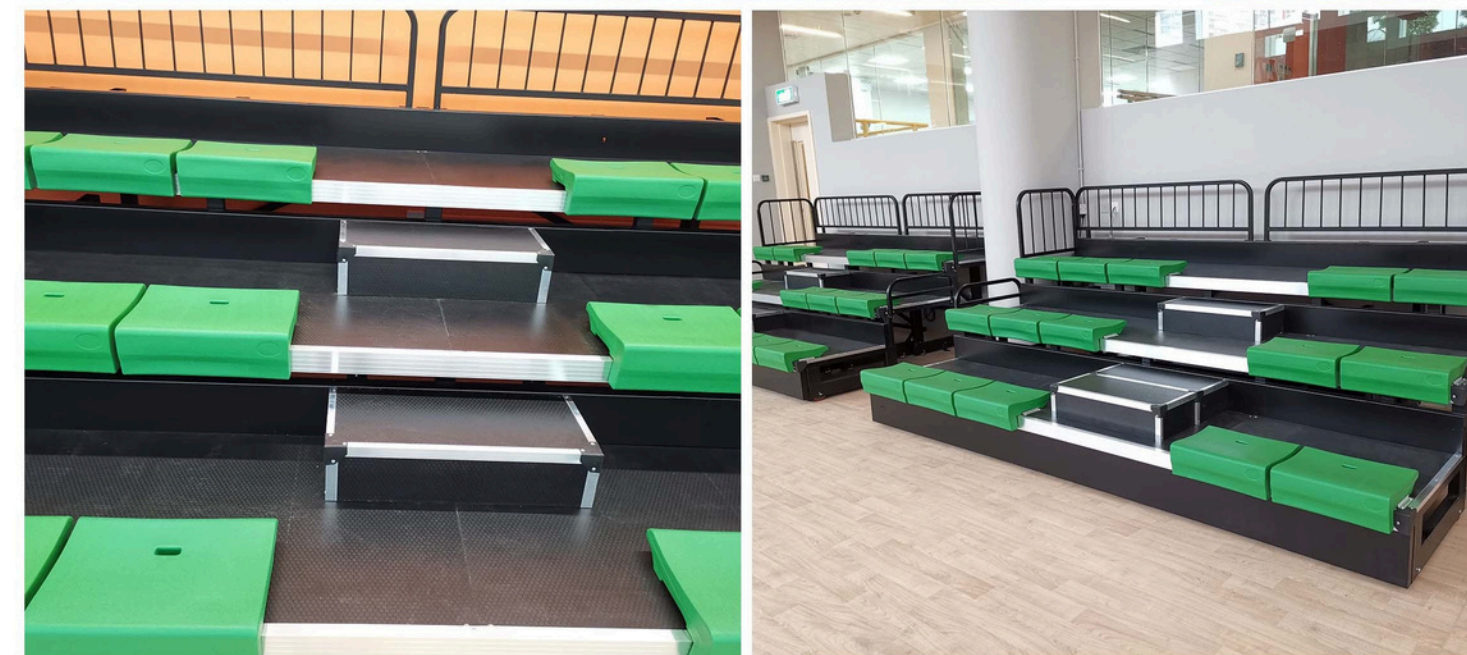
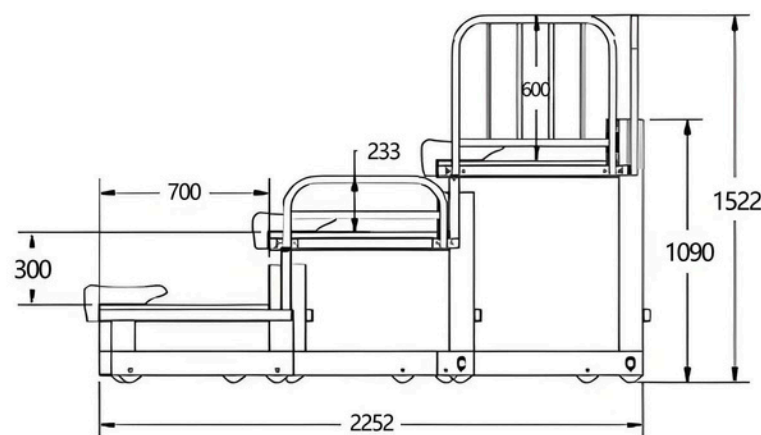
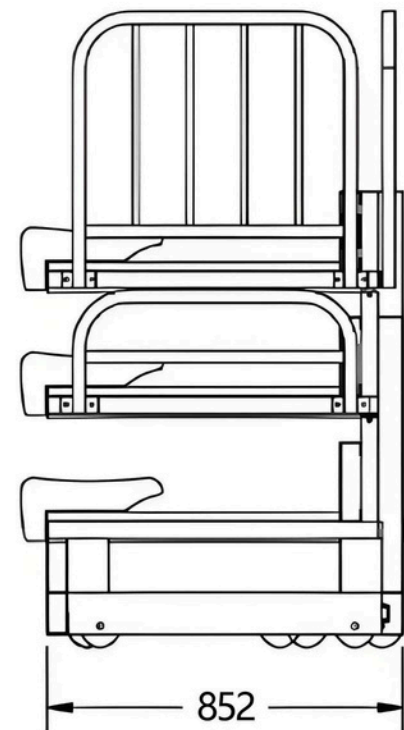
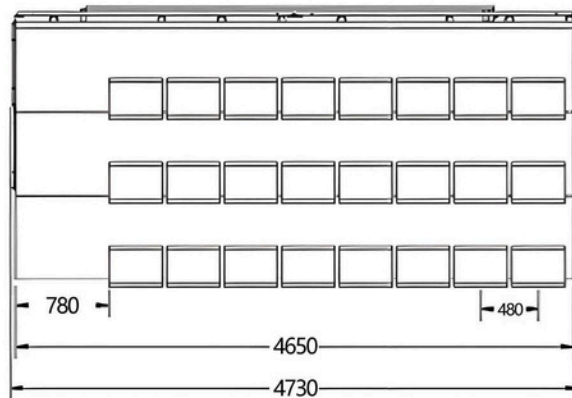

- Retractable Bleachers Bench Seats
- ▶ Model:BL-STE-07-CD
- ▶ Metal Treatments:Powder Coating
- ▶ Pedal: 18 mm melamine multilayer plywood
- ▶ Loading Capacity:≥5KN per square meters
- ▶ Guard Rail:2 Side safety Rail
- ▶ Aisles:1 meters width
- ▶ Applications:Multifunctional hall
- ▶ Structure Pillars: 50x100x3.5mm
- ▶ Beam:50x220x3mm
- ▶ Telescopic Mode: Electric
- ▶ Rows:7 (Customized size accepted)
- ▶ Row Depth:750mm
- ▶ Row Rise:300mm
- ▶ Seating Capacity:160
- ▶ Seats C/C:480mm
- ▶ L/W/H:9000x7500x3000mm
- ▶ Seats Materail:Plank
- ▶ Design Standard:EN-13200



Hong Kong, China

- Retractable Bleachers Bench Seats
- ▶ Model:BL-STE-03-CD
- ▶ Metal Treatments:Powder Coating
- ▶ Pedal: 18 mm melamine multilayer plywood
- ▶ Loading Capacity:≥5KN per square meters
- ▶ Guard Rail:2 Side safety Rail
- ▶ Aisles:1 meters width
- ▶ Applications:Multifunctional hall
- ▶ Structure Pillars: 50x100x3.5mm
- ▶ Beam:50x220x3mm
- ▶ Telescopic Mode: Electric
- ▶ Rows:3 (Customized size accepted)
- ▶ Row Depth:750mm
- ▶ Row Rise:300mm
- ▶ Seating Capacity:30
- ▶ Seats C/C:480mm
- ▶ L/W/H:6000x2250x900mm
- ▶ Seats Materail:Plank
- ▶ Design Standard:EN-13200

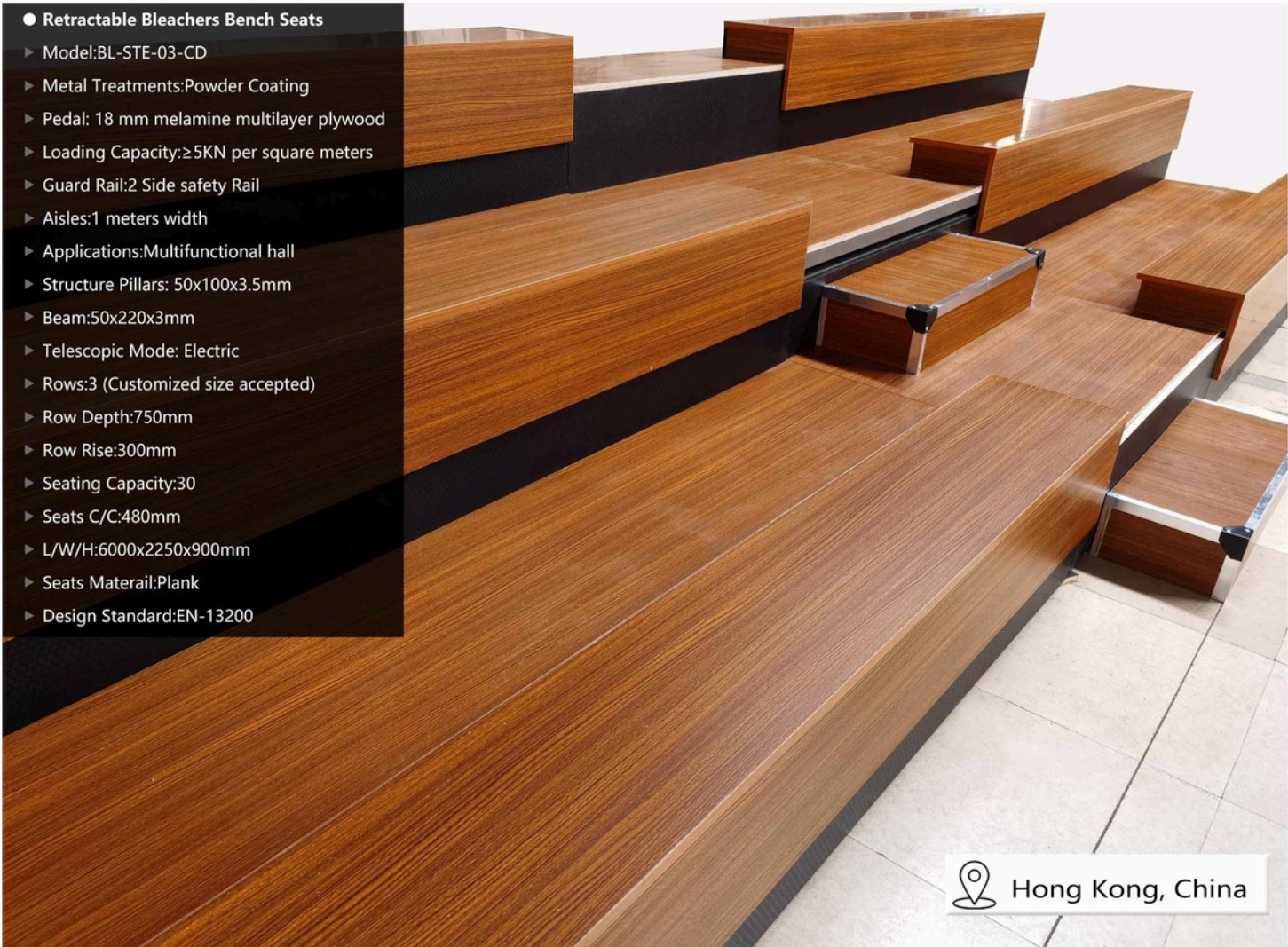

Hong Kong, China

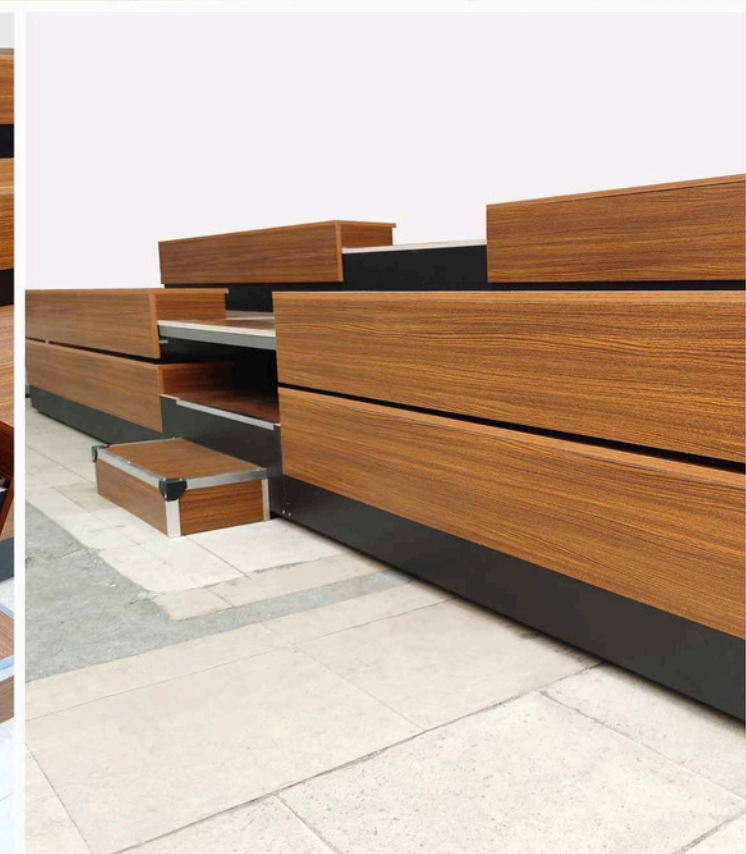
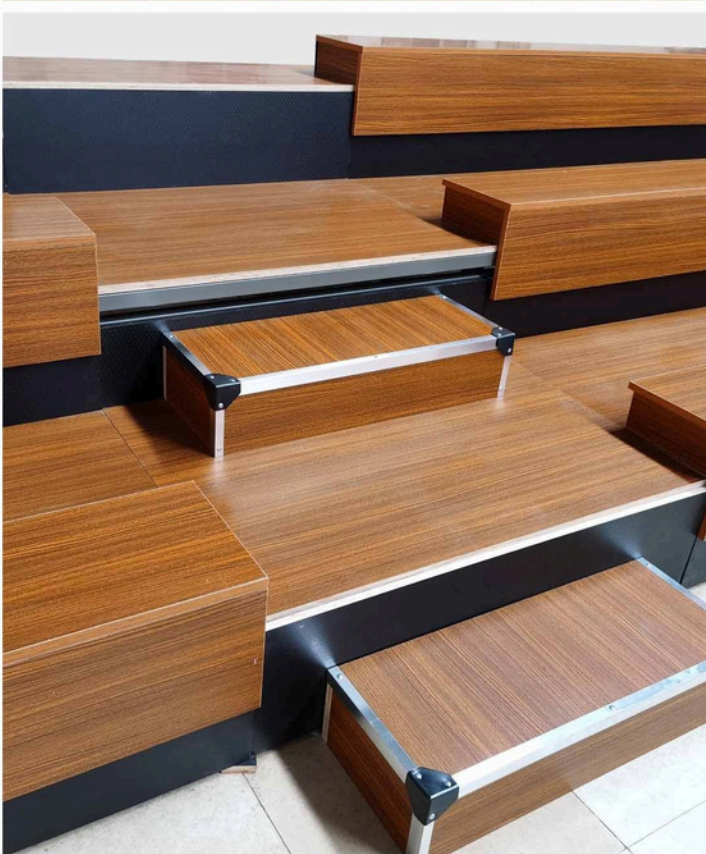
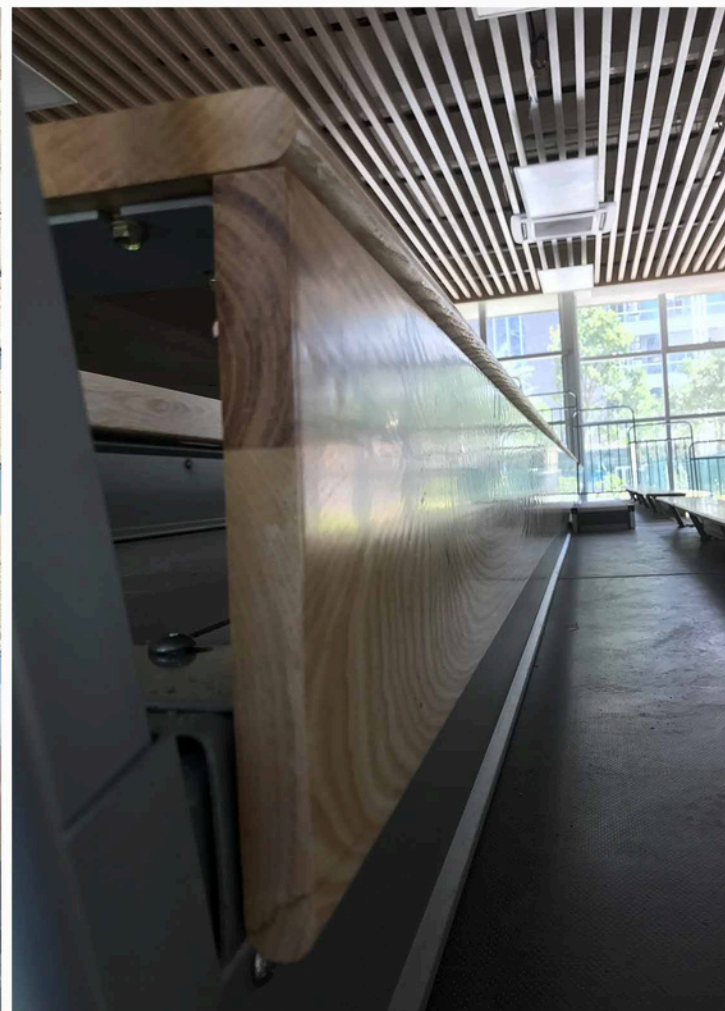

Electric Folding Stage

Model: ES-01

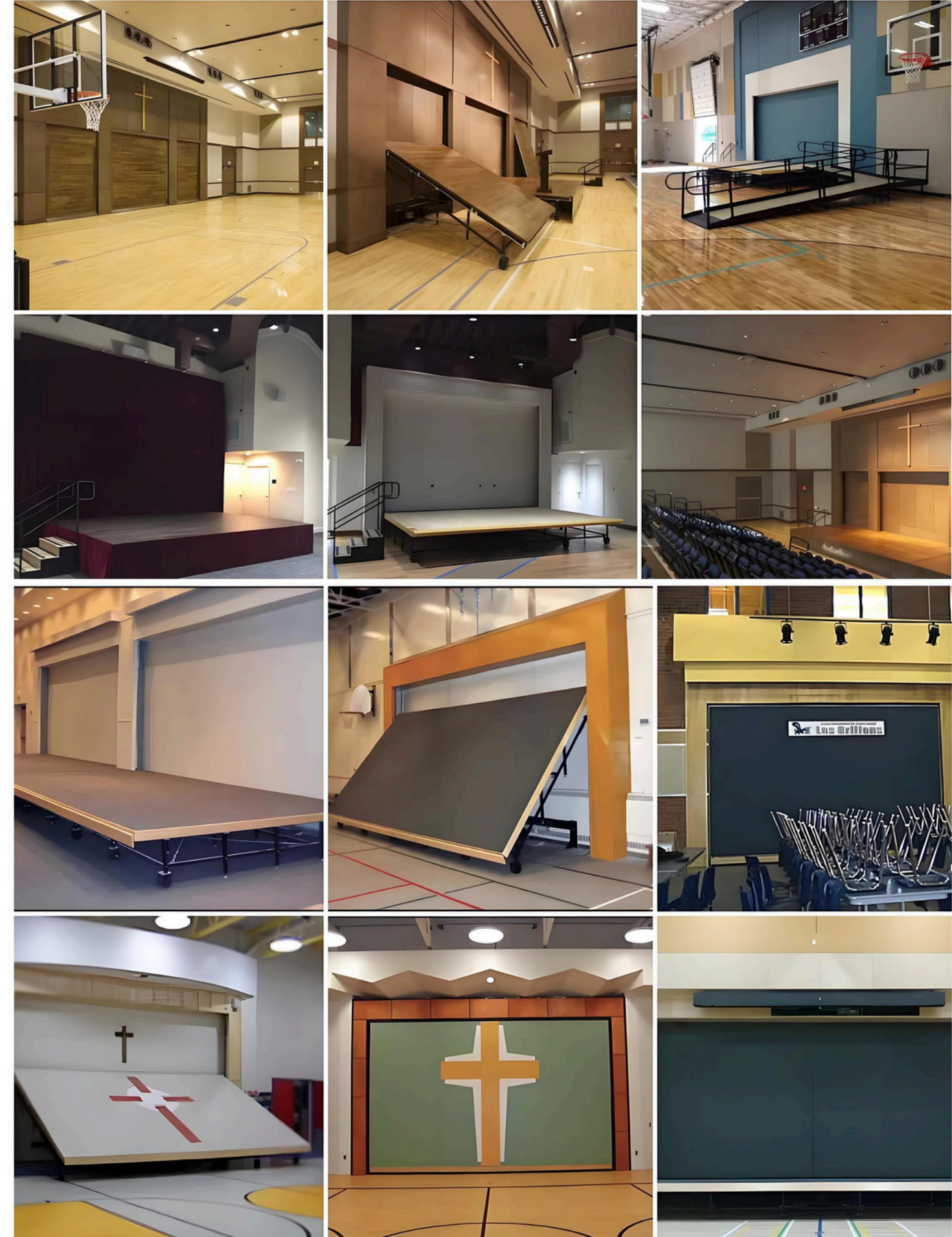
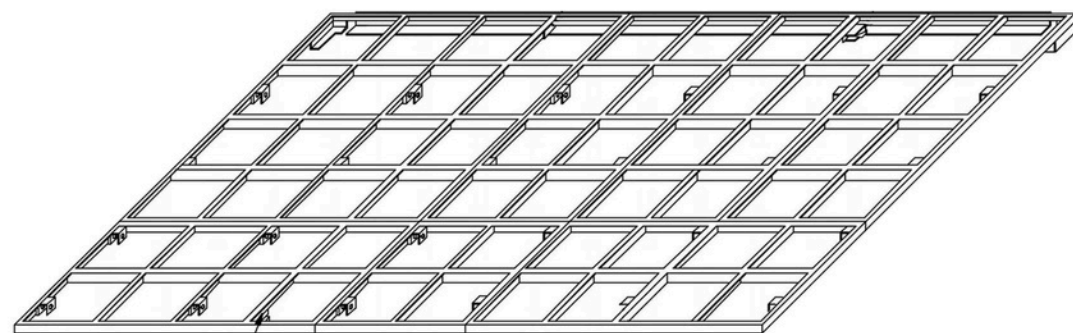
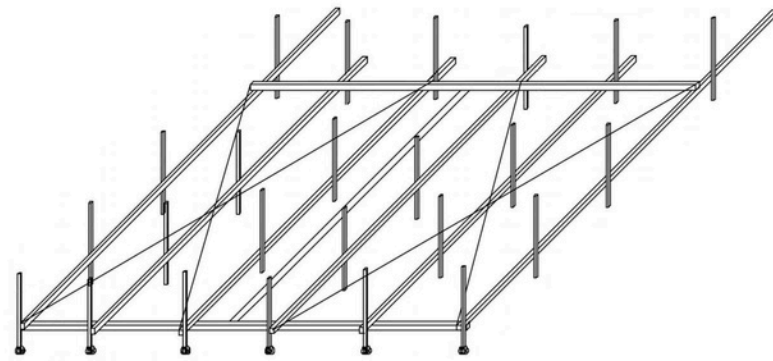
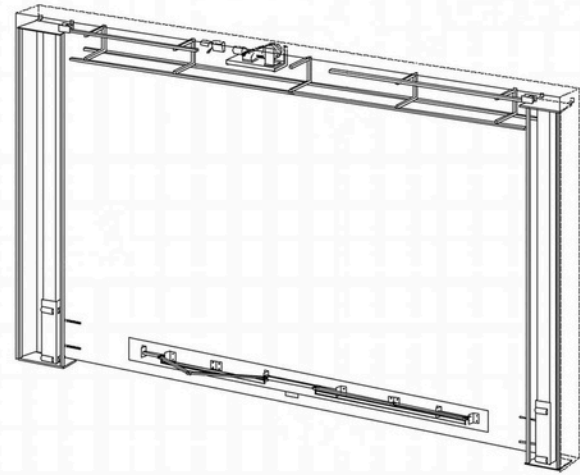
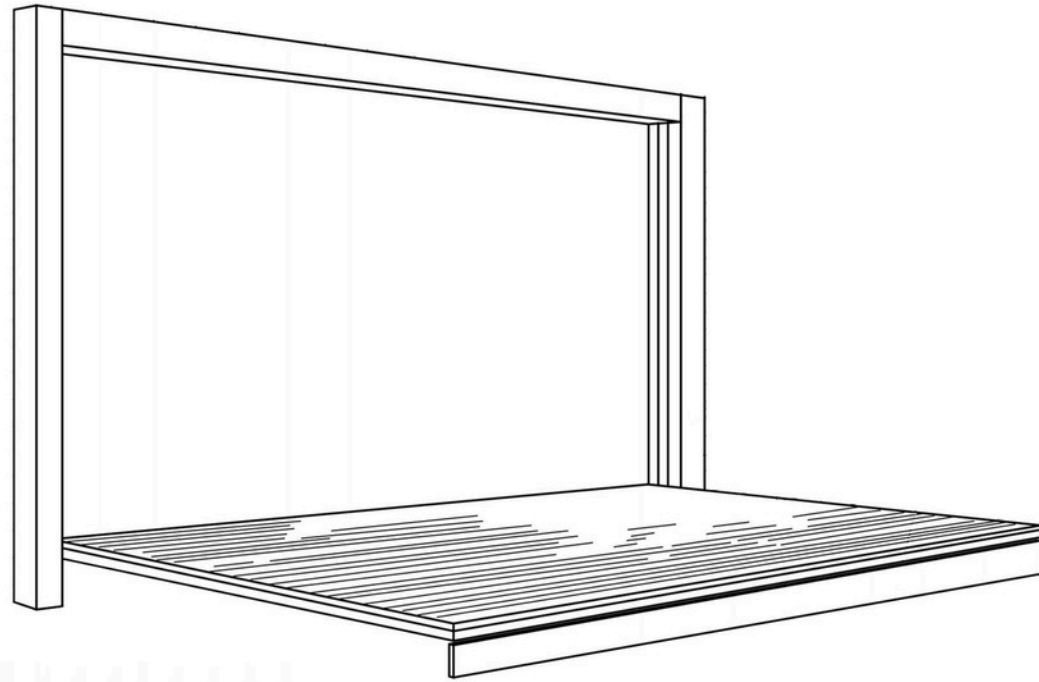



MAIGA & CO[®]

INTERNATIONAL



ALLAH KI YIRIWA



+90 535 941 47 28

+223 74 73 00 06

WWW.MAIGACO.COM

MAHAMADOUAIGA906@YAHOO.COM